



Fundamentals of electricity systems and economics

Dr. Andreas Poulikkas

Ph.D, D.Tech, FIET

Chairman

apoulikkas@cera.org.cy

Contents

- **Introduction to the subject**
- **Power system reliability**
- **Components of a power system**
- **Renewable energy sources**
- **Operation and control**
 - **The economic dispatch problem**
 - **The unit commitment problem**

Introduction to the subject

What is a power system?



- **A system that deals with the business of the electrical energy**
 - **Generation**
 - **Transmission**
 - **Distribution**
- **Largest and most complex manmade system**
- **PS provides a vital service to the society**

What is a power system? *(cont.)*

- **Electrical power is somewhat like the air we breath**
 - **We think about it only when it is missing**
- **PS should be operated with the goal of achieving:**
 - **Highest reliability standards**
 - **Lowest operation cost**
 - **Minimum environmental impacts**

Power system reliability

The fundamental requirement of electrical power supply:

Get me what I want, when I want it !!!

Power system reliability

- **adequacy**, PS ability to satisfy customers needs both in power and electrical energy
- **security**, PS ability to remain in operation after sudden disturbances

Power system reliability (the 6 must)

- Generation capacity **must** be greater than load
- Transmission **must** not be overloaded
- Voltages **must** be within limits
- **Must** be able to withstand loss of generator
- **Must** be able to withstand loss of transmission line
- **Must** not lose stability during short-circuit

Energy Not Serve (ENS)

- **The expected amount of energy not being served to consumers by the system due to**
 - **system capacity shortages**

or

 - **unexpected severe power outages**
- **The cost to the economy due to power system weakness in satisfying the electricity demand**

Two bus power system

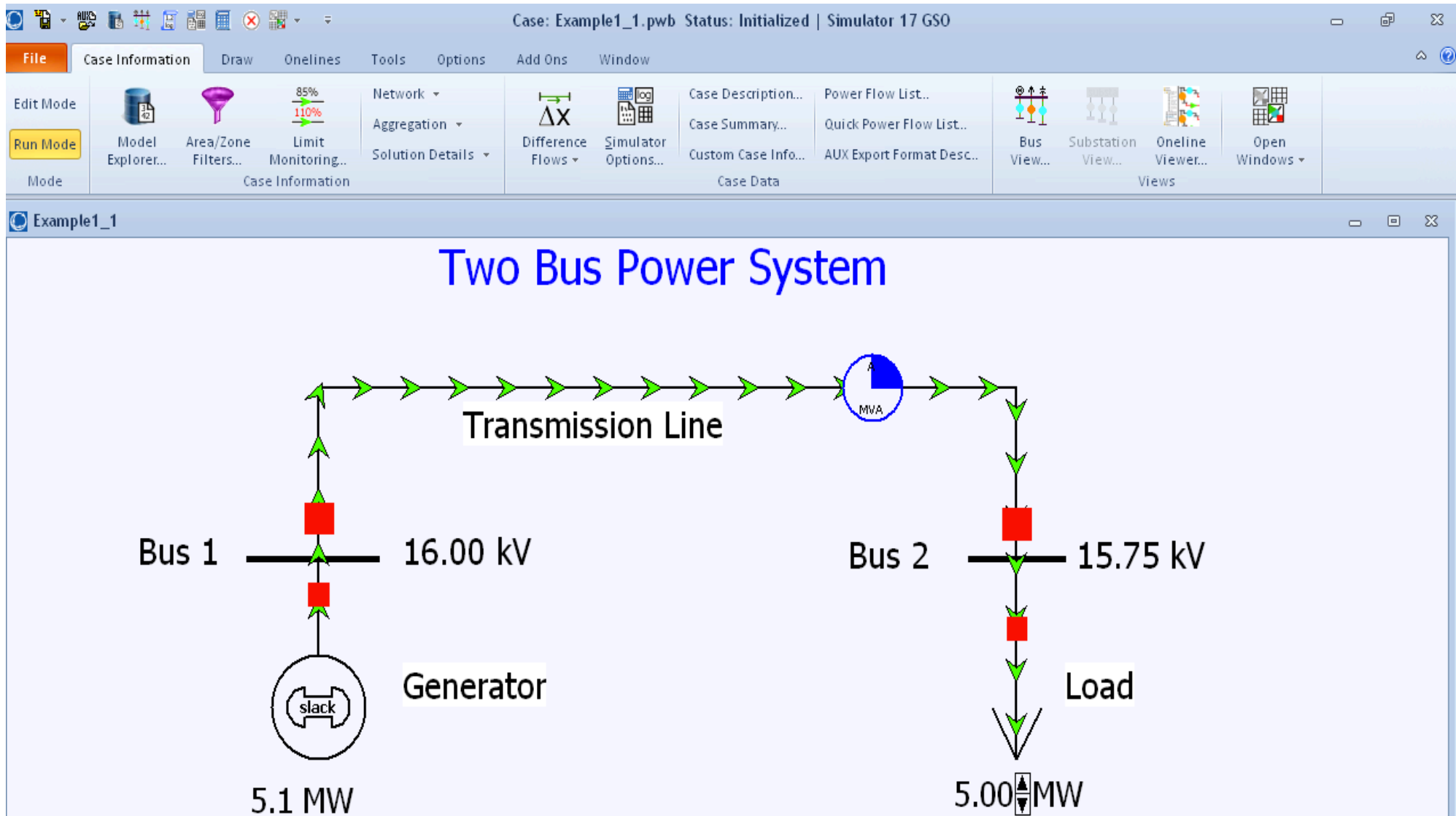

Three bus power system

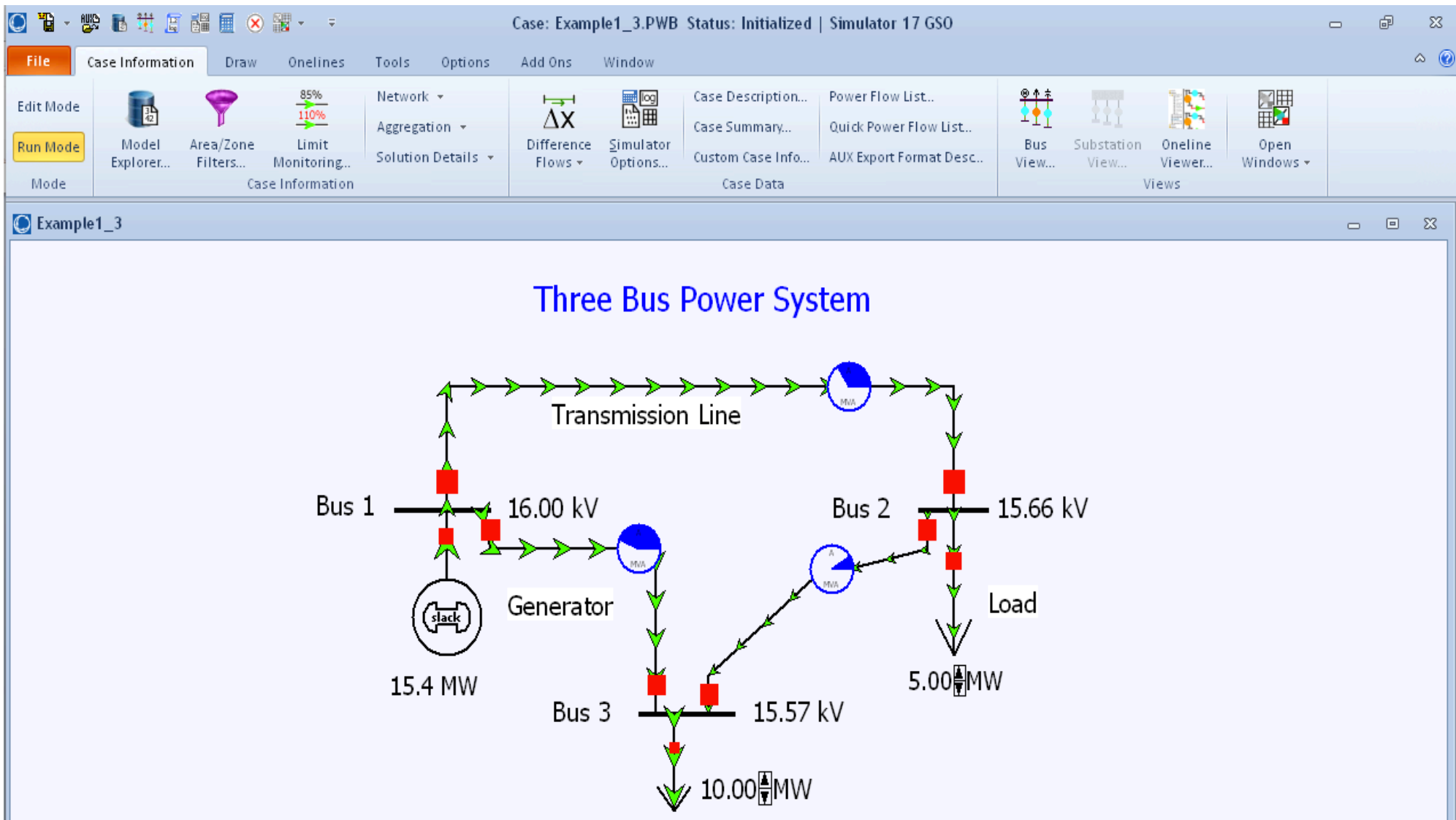

Power system design

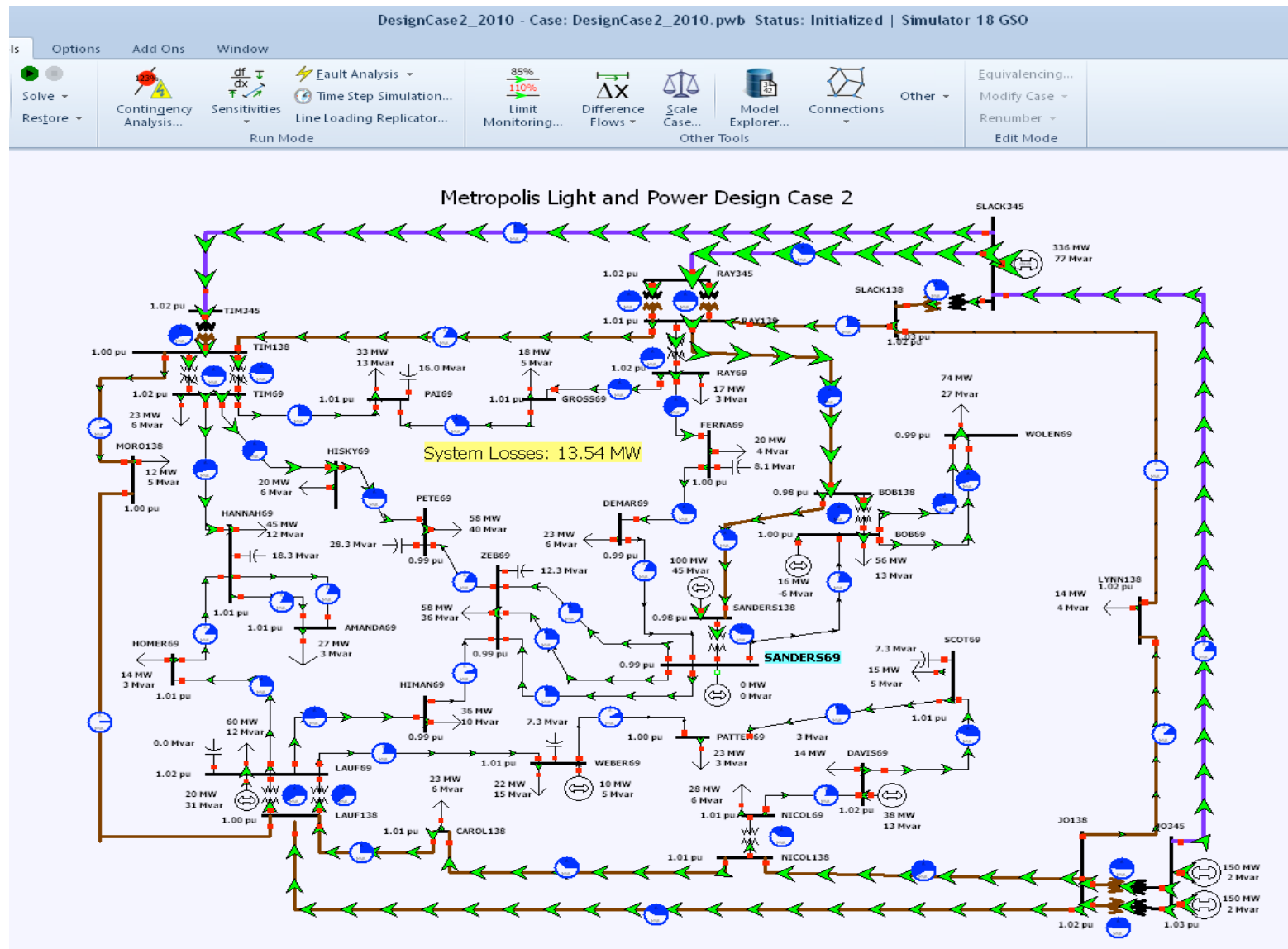

Blackouts (or brownouts)

- Due to natural disasters
- Due to human error



Natural disasters



Human error



Components of a power system

PS functions

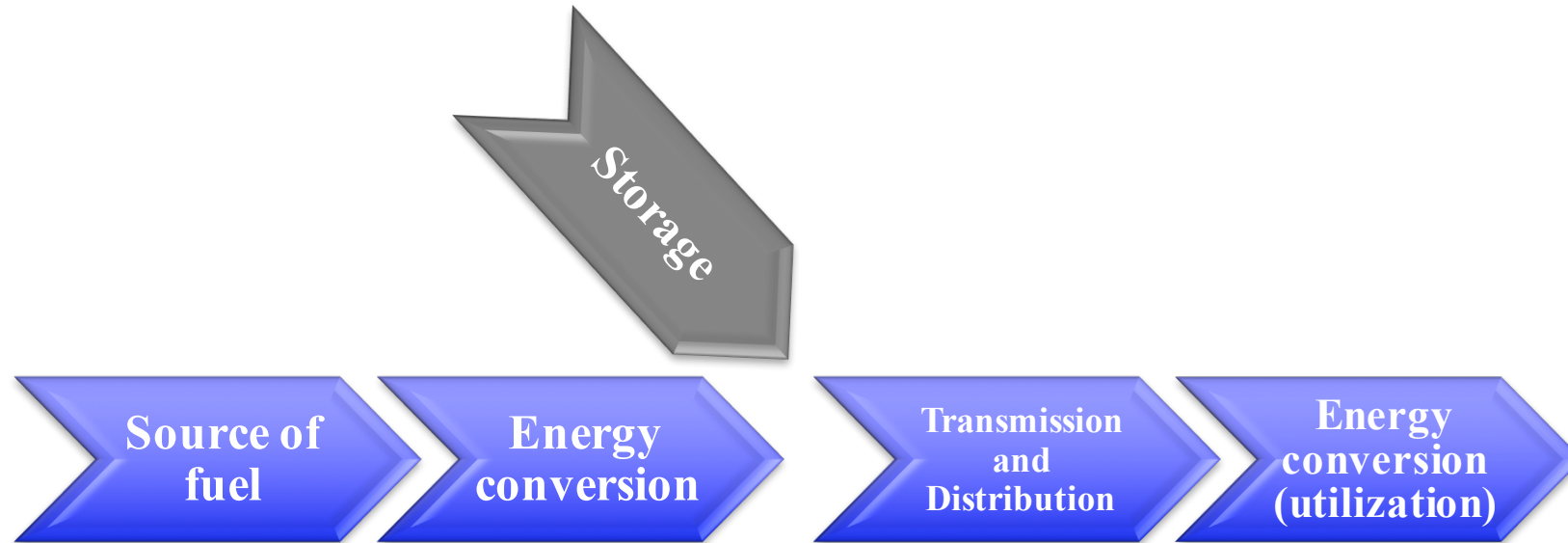

- **Consumption devices are part of the PS and need to be modelled in a PS analysis**
- **However, they are not owned or controlled by the power system operators**

Basic PS layout

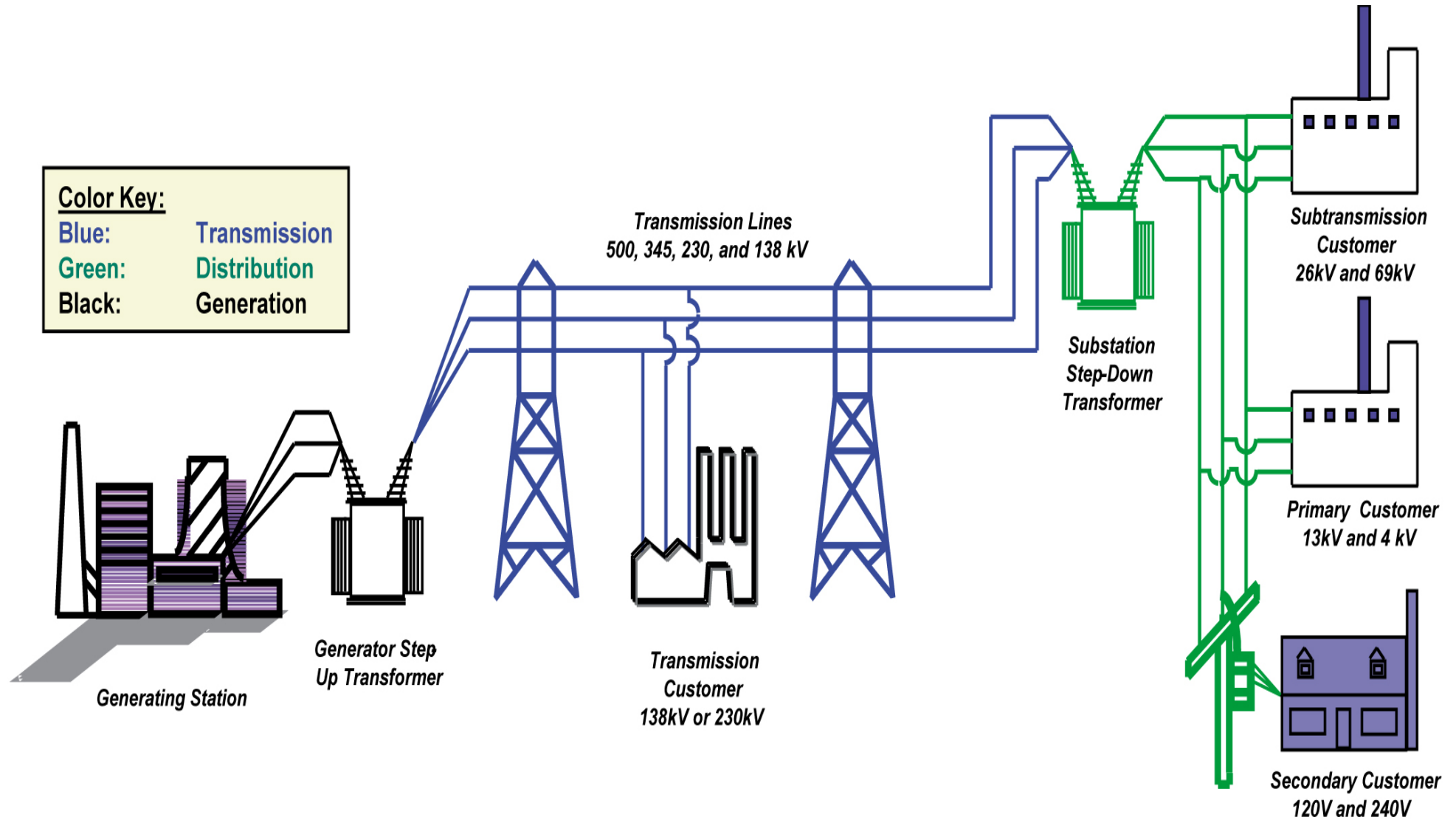

Power generation

- **Takes place in power stations which may be geographically dispersed**
 - **Near big cities**
 - **Near sources of fuel**
- **A power station may house more than one power generation units**

Power generation technologies

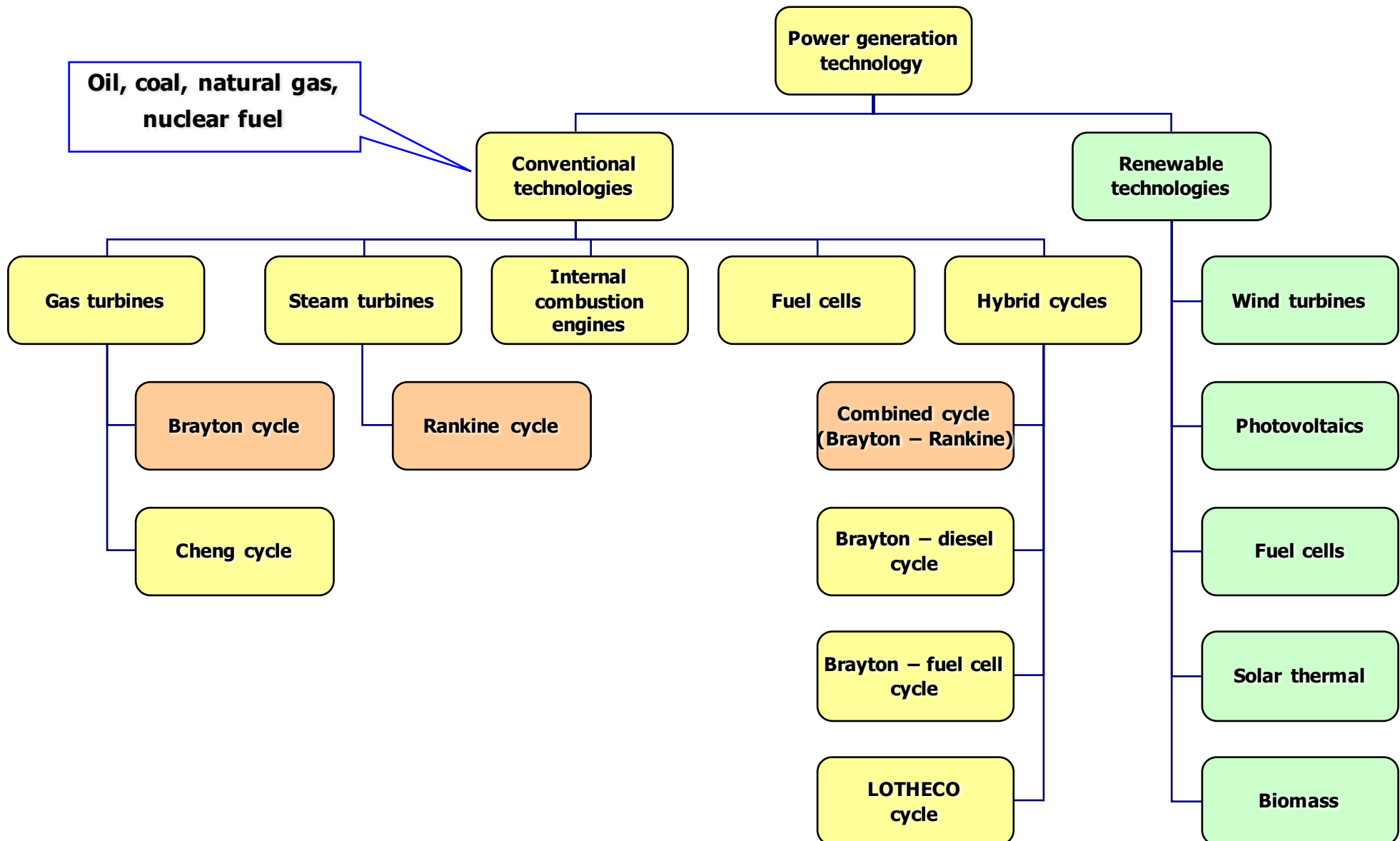

Simulation of a steam plant (Rankine cycle)

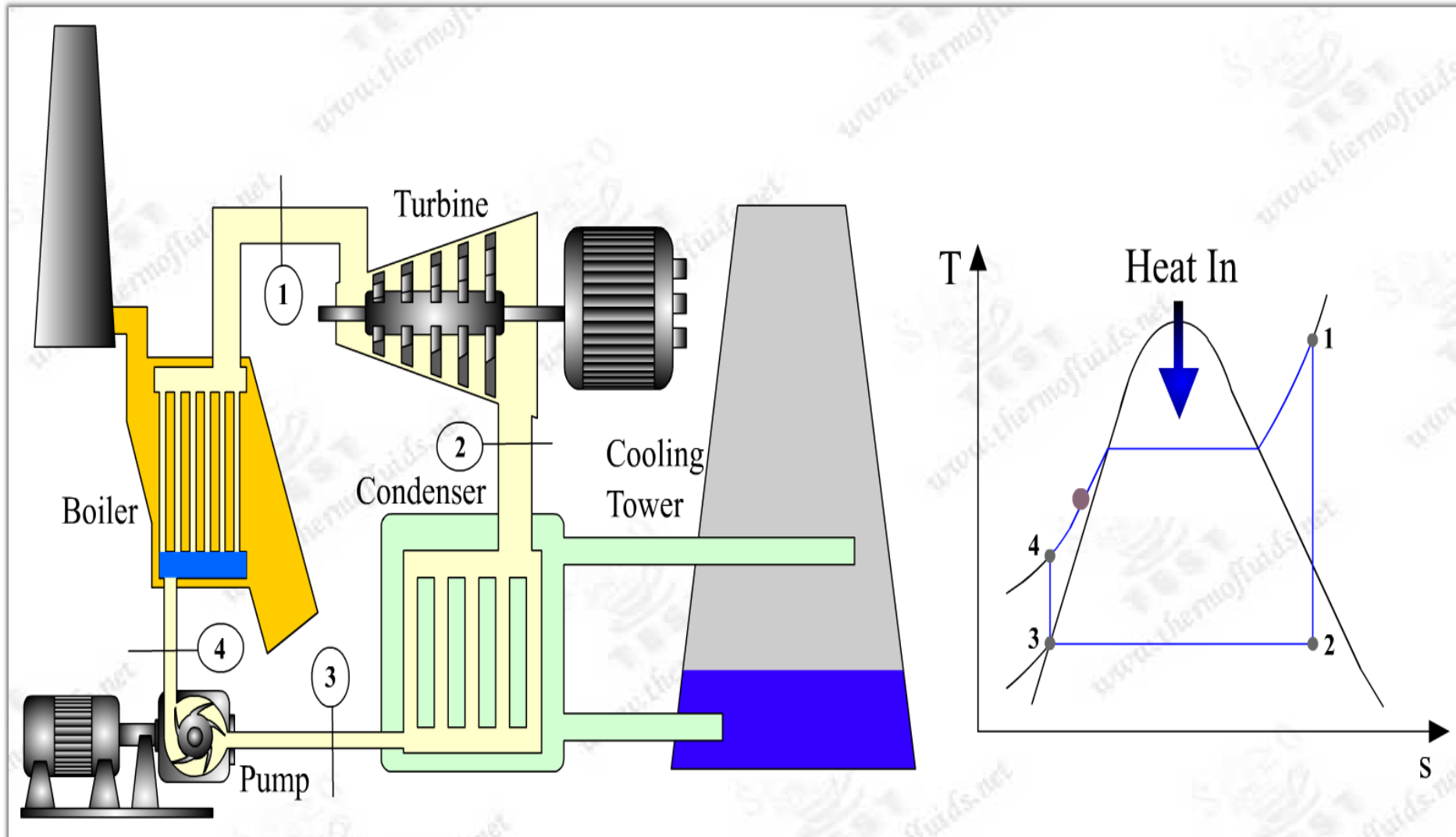

openvaporcycle[1].swf

Simulation of power gas turbine cycle (Brayton cycle)

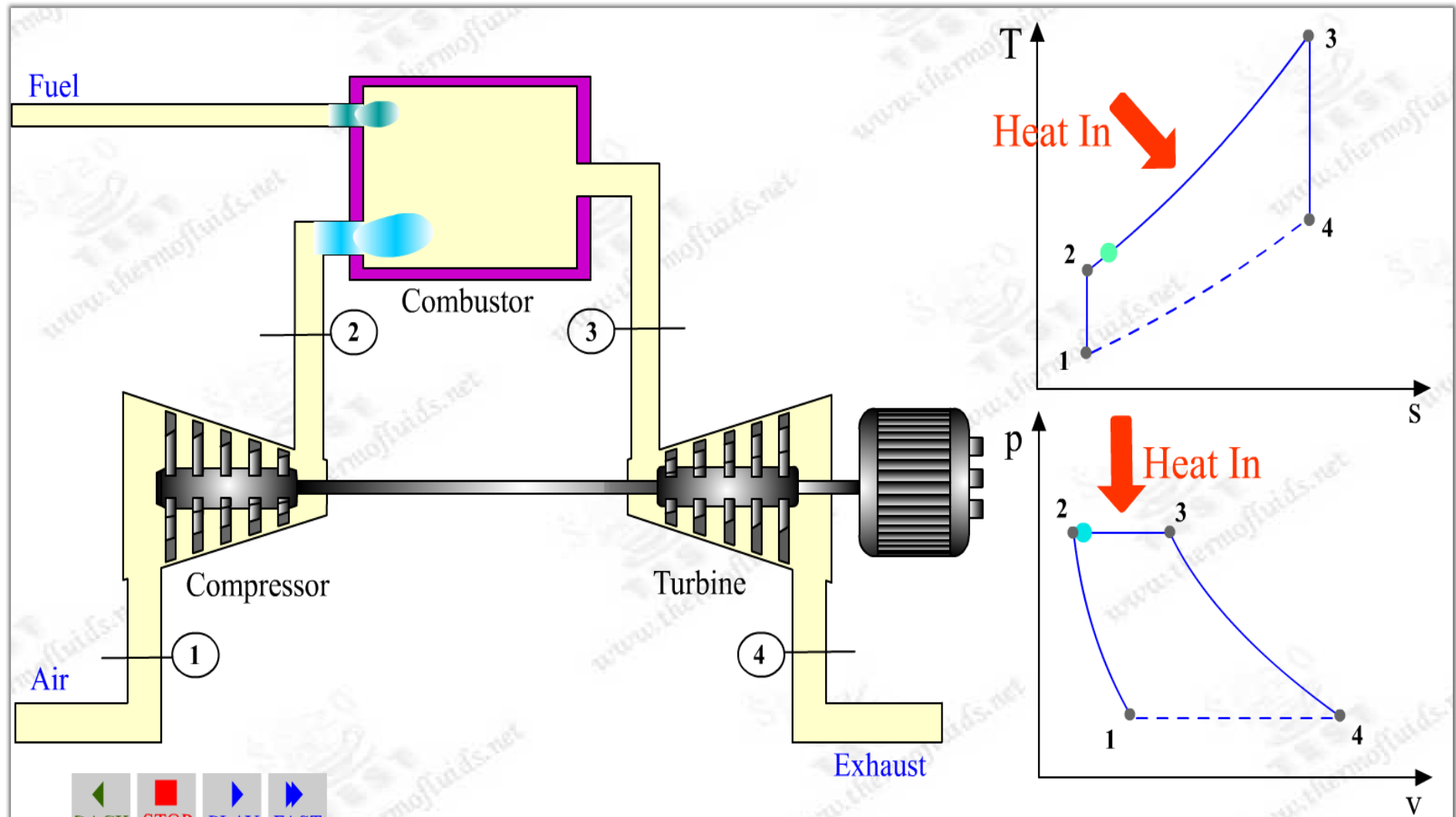

openBraytonCycle[1].swf

Simulation of a combined cycle

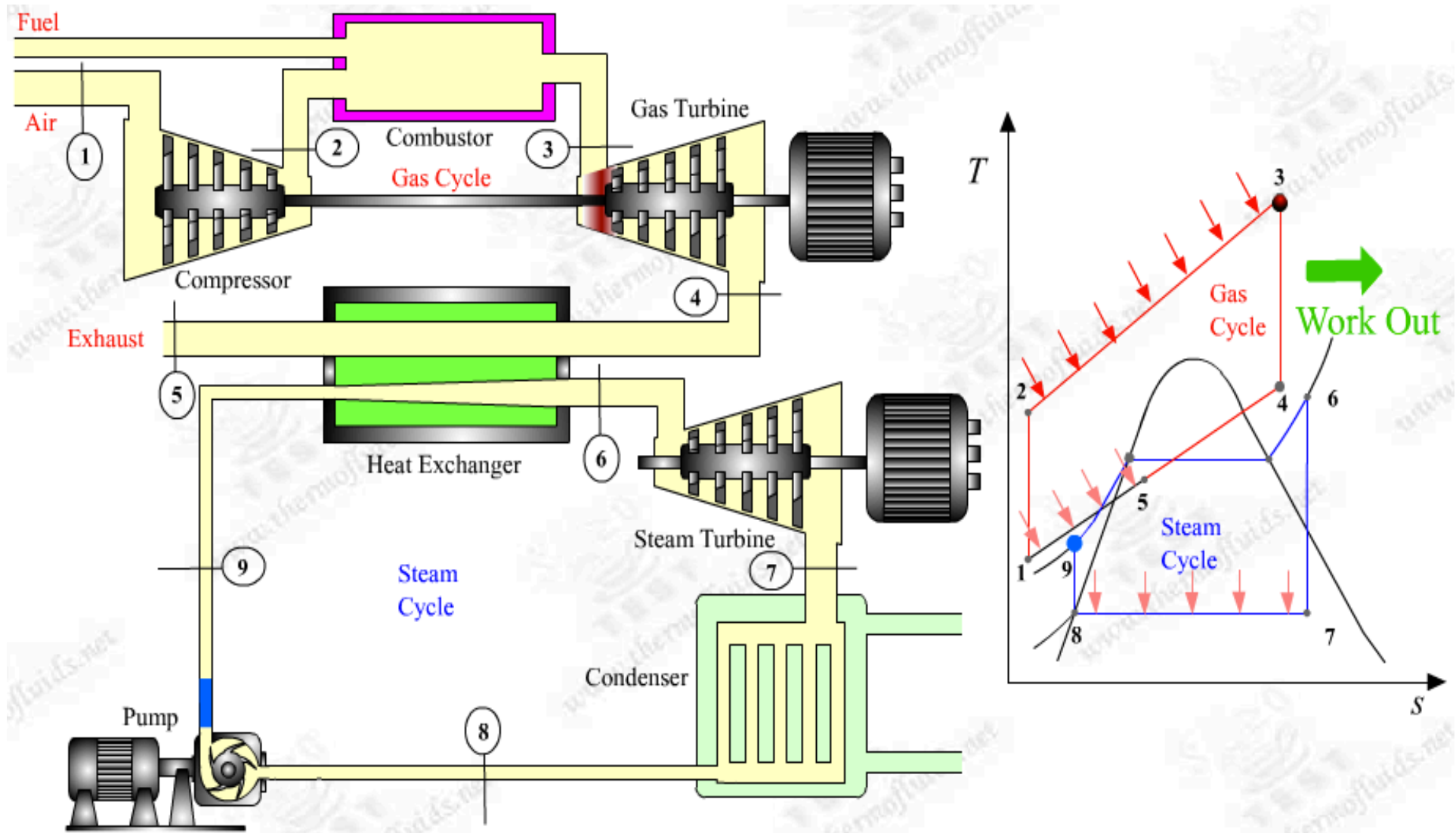

combinedCycle[1].swf

Renewable energy sources

The rise of renewables

1. Wind

2. Solar

3. Biomass

4. Hydro

5. Geothermal

6. Wave

7. Ocean currents

8. Tidal

The fundamental requirement of electrical power supply:

Get me what I want, when I want it !!!

Intermittent energy source

- **Any source of energy that is not continuously available**
- **May be quite predictable**
- **Cannot be dispatched to meet the demand of a power system**
- **For dispatching need storage**

Wind generation vs demand in Germany (E.ON TSO area)

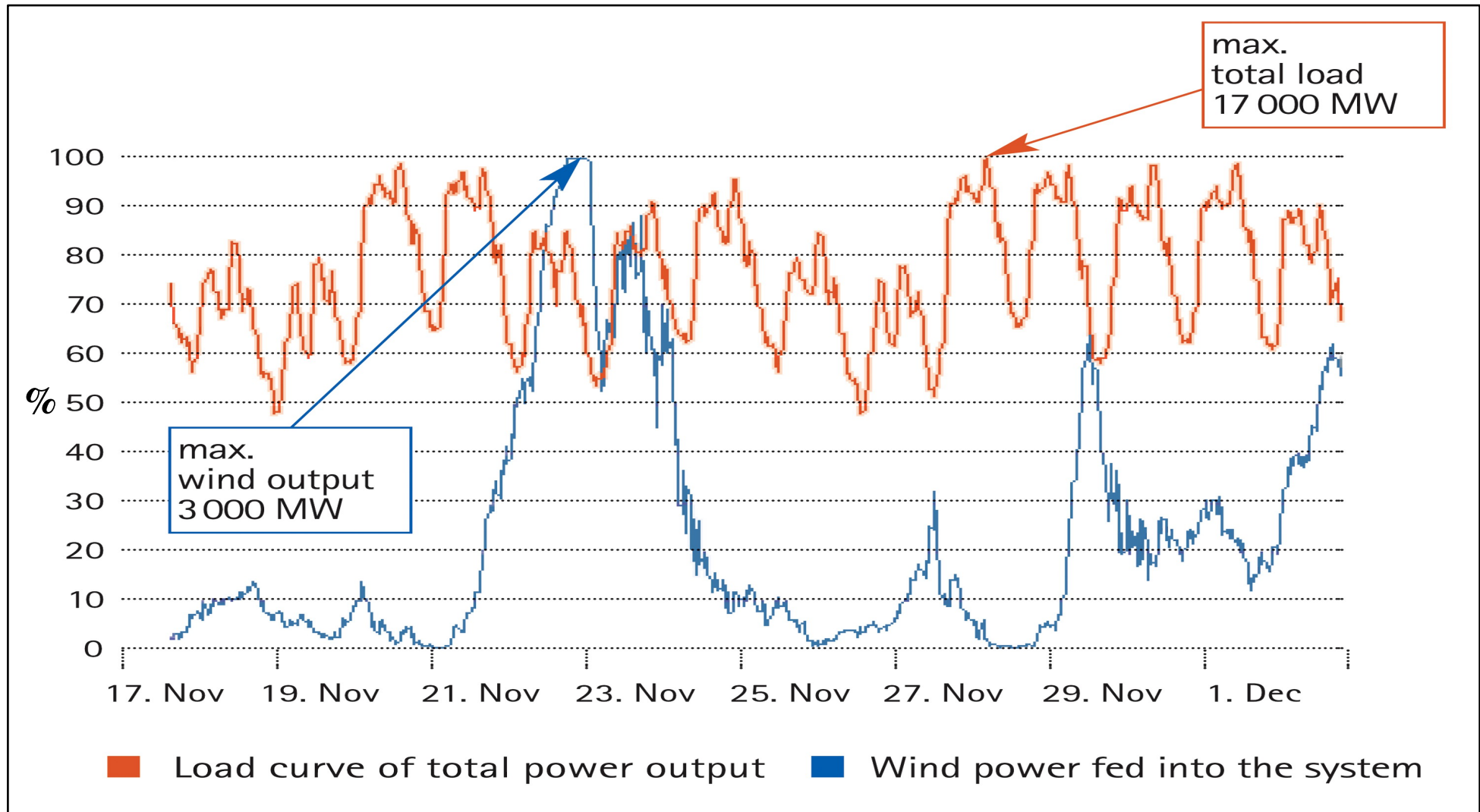

Wind generation vs demand in USA (TUX Arizona area)

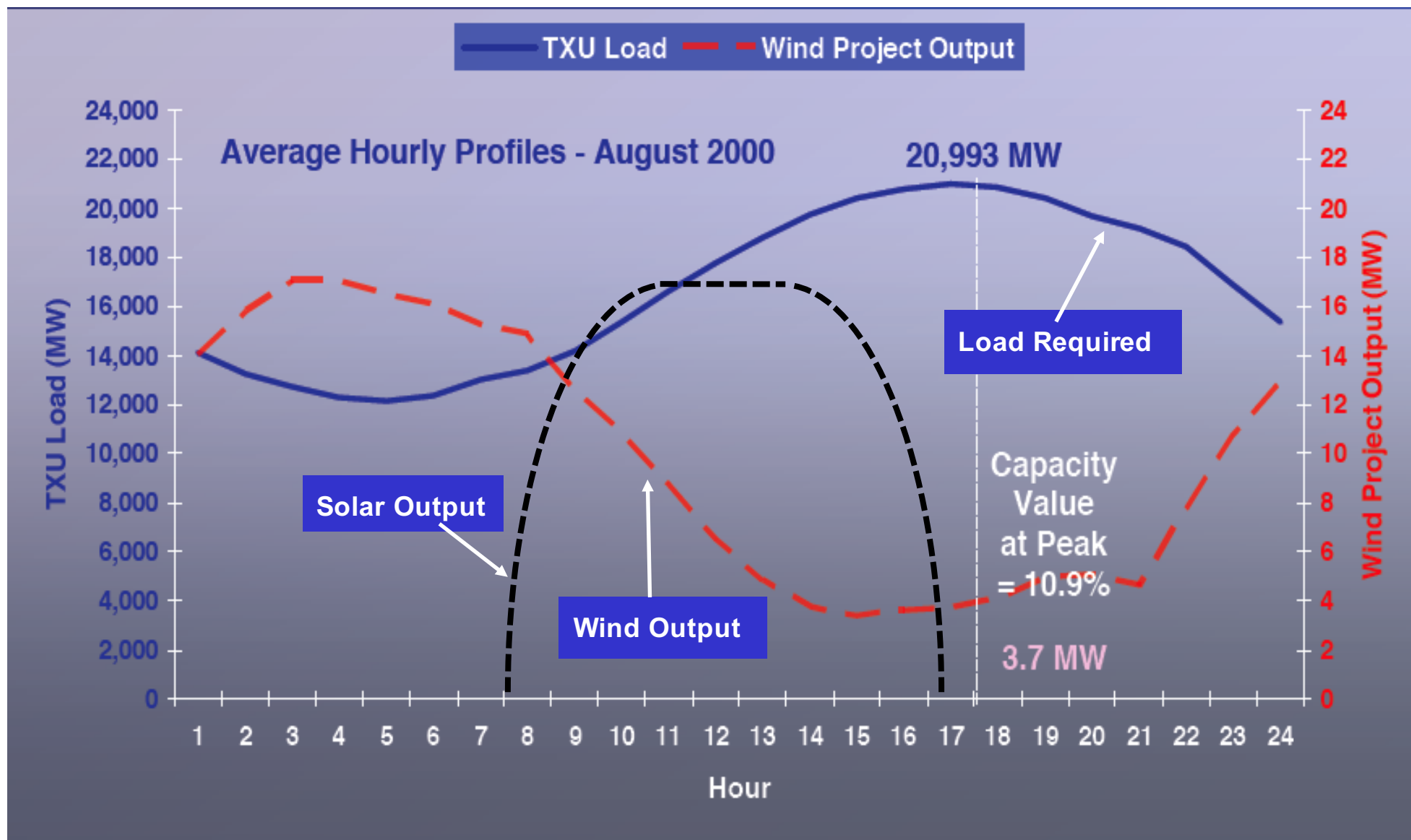

Wind generation

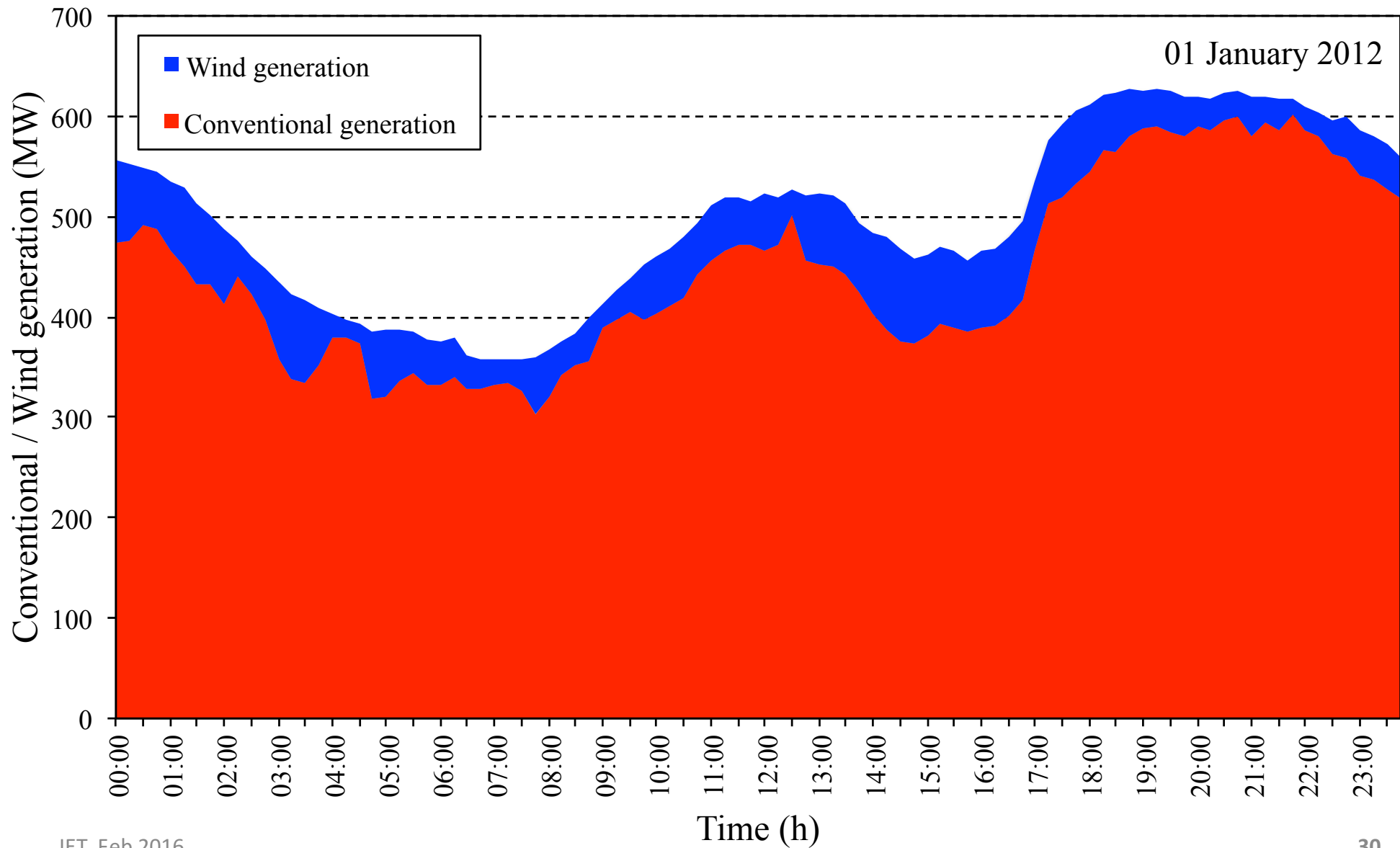

Wind generation

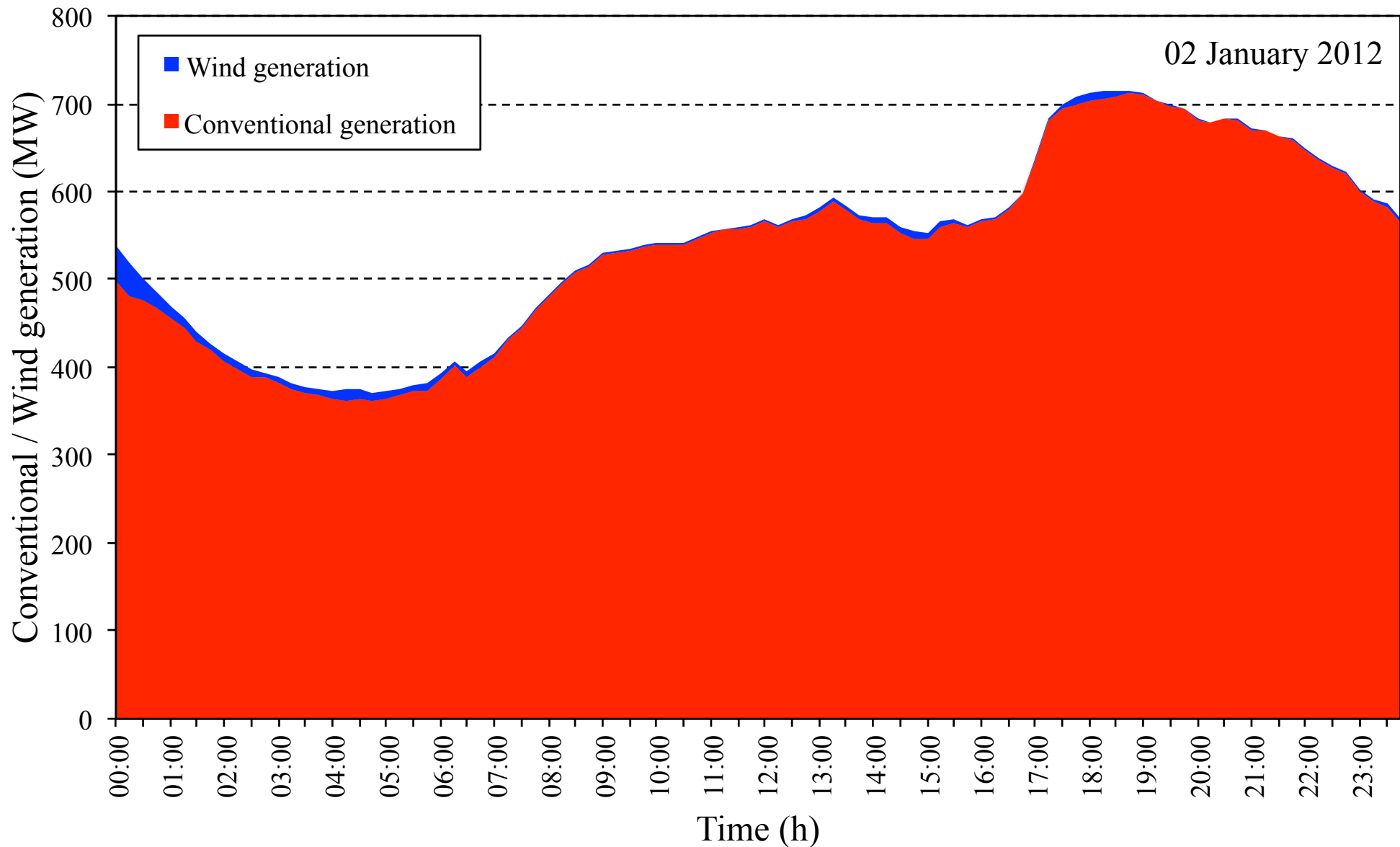

Example of PV generation during Summer time*

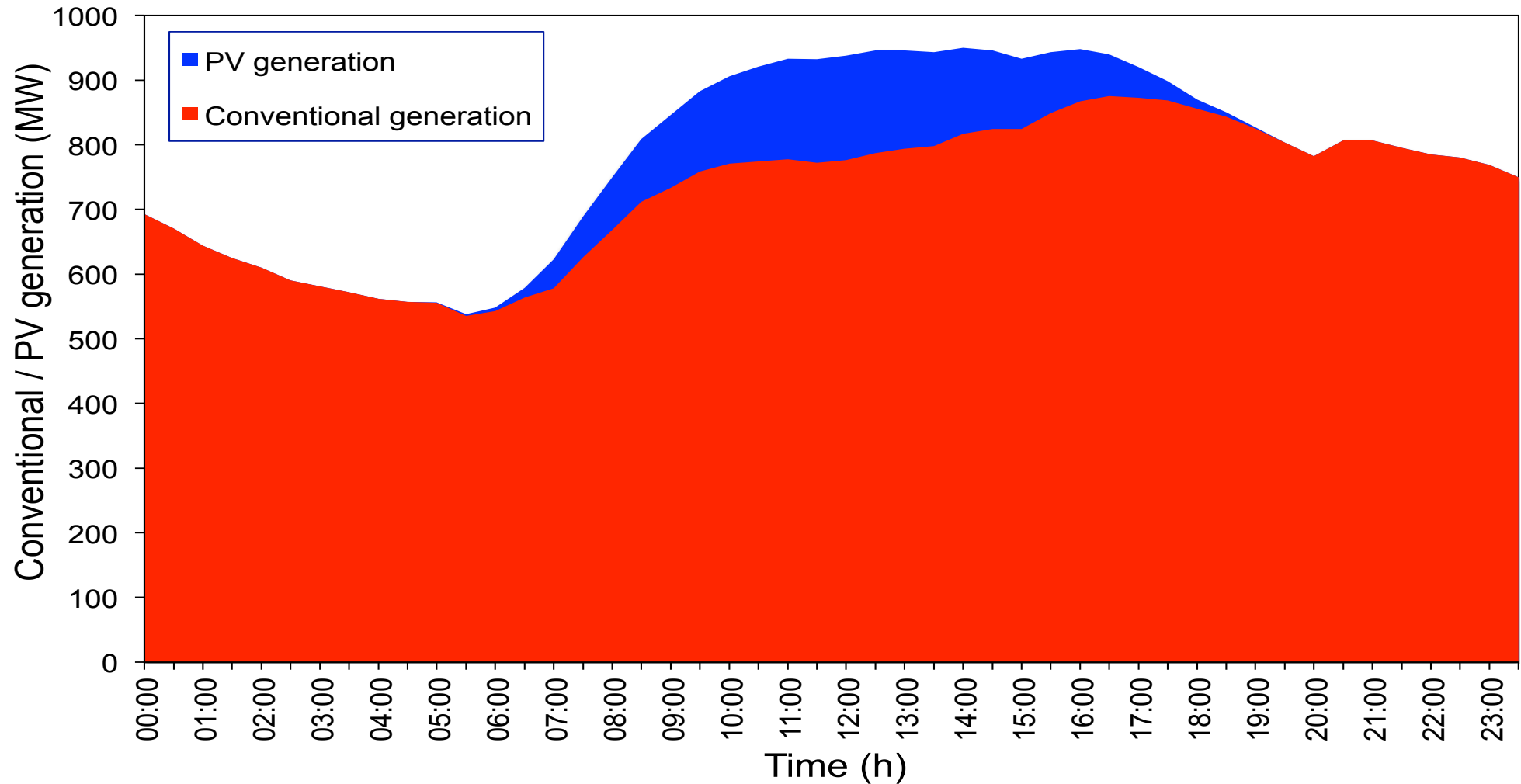

* Poullikkas A., 2009, "Parametric cost-benefit analysis for the installation of photovoltaic parks in the island of Cyprus", *Energy Policy*

Example of PV generation during Winter time*

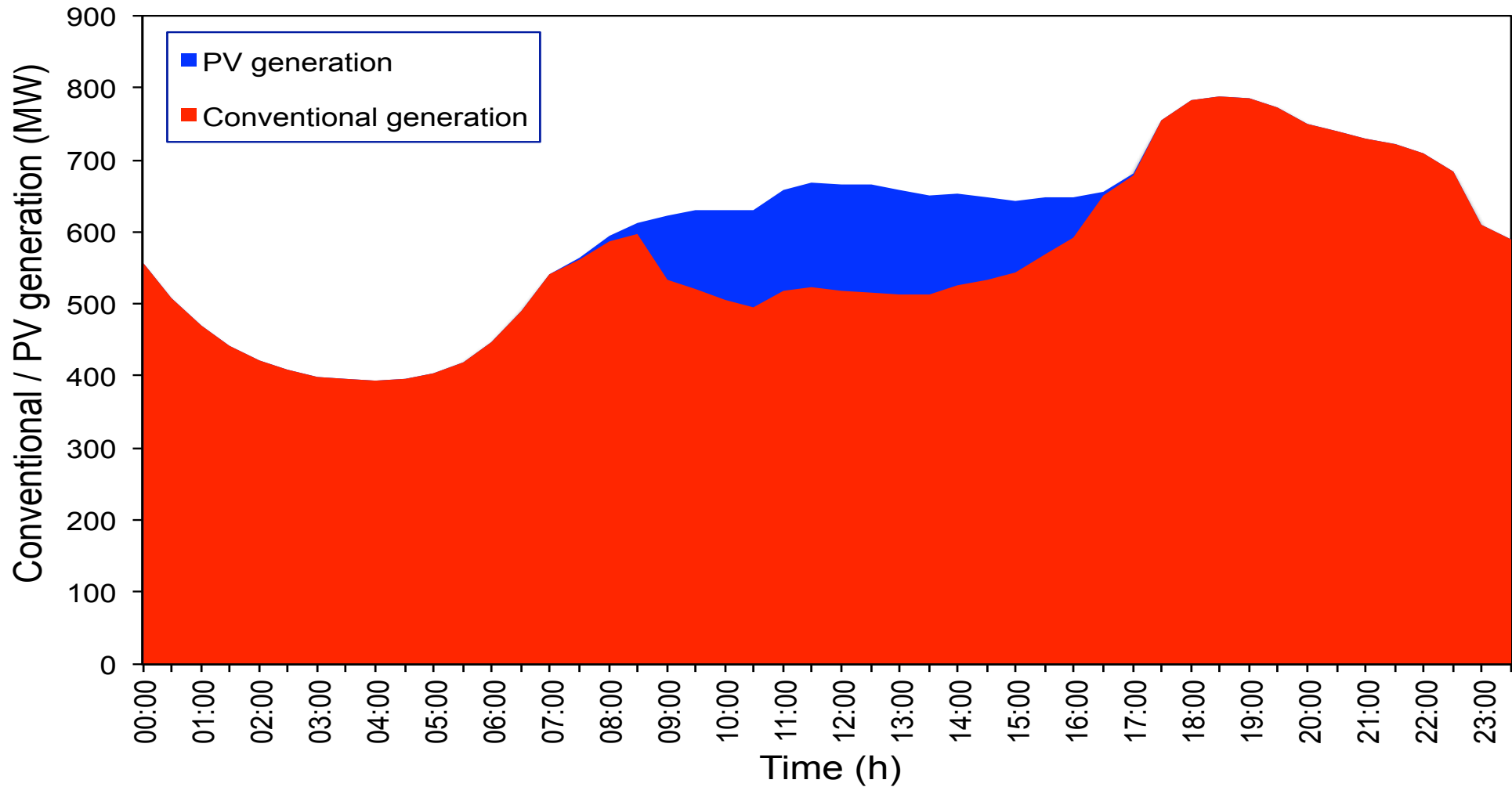

* Poullikkas A., 2009, "Parametric cost-benefit analysis for the installation of photovoltaic parks in the island of Cyprus", *Energy Policy*

Daily load curve (the 'camel curve')

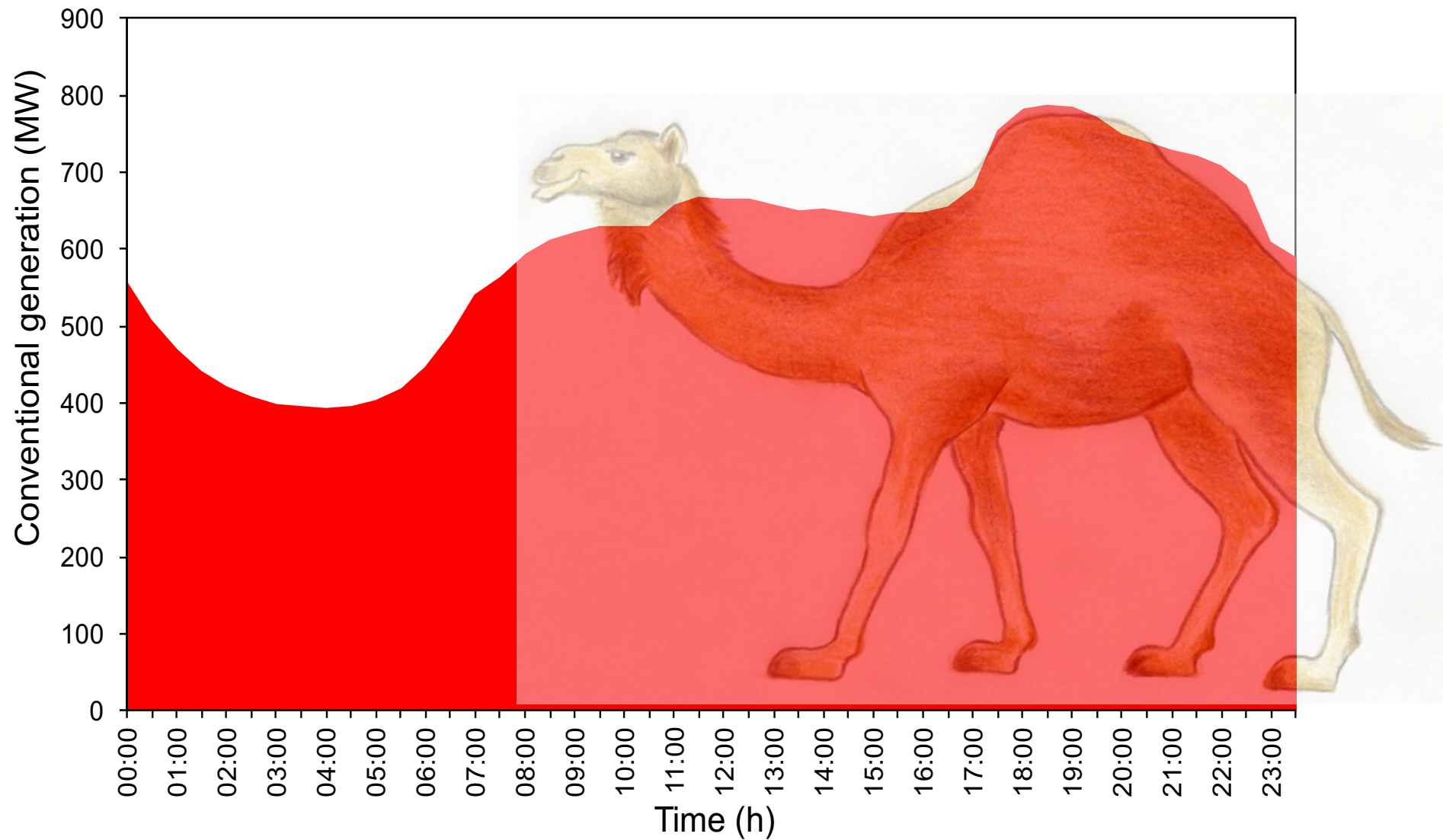

Effect of PV generation on load curve (the 'duck curve')

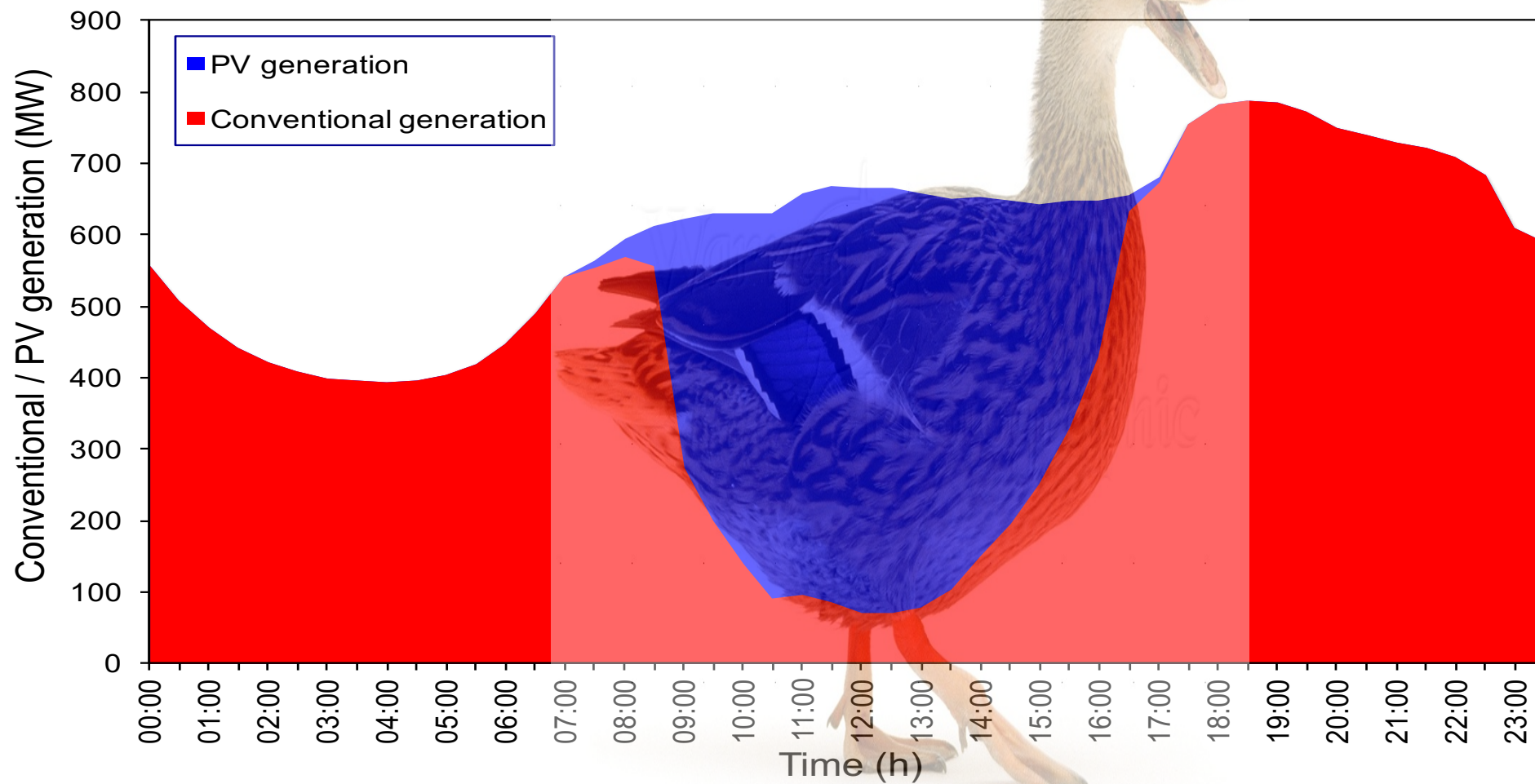

Steep ramping needs and overgeneration risk in California

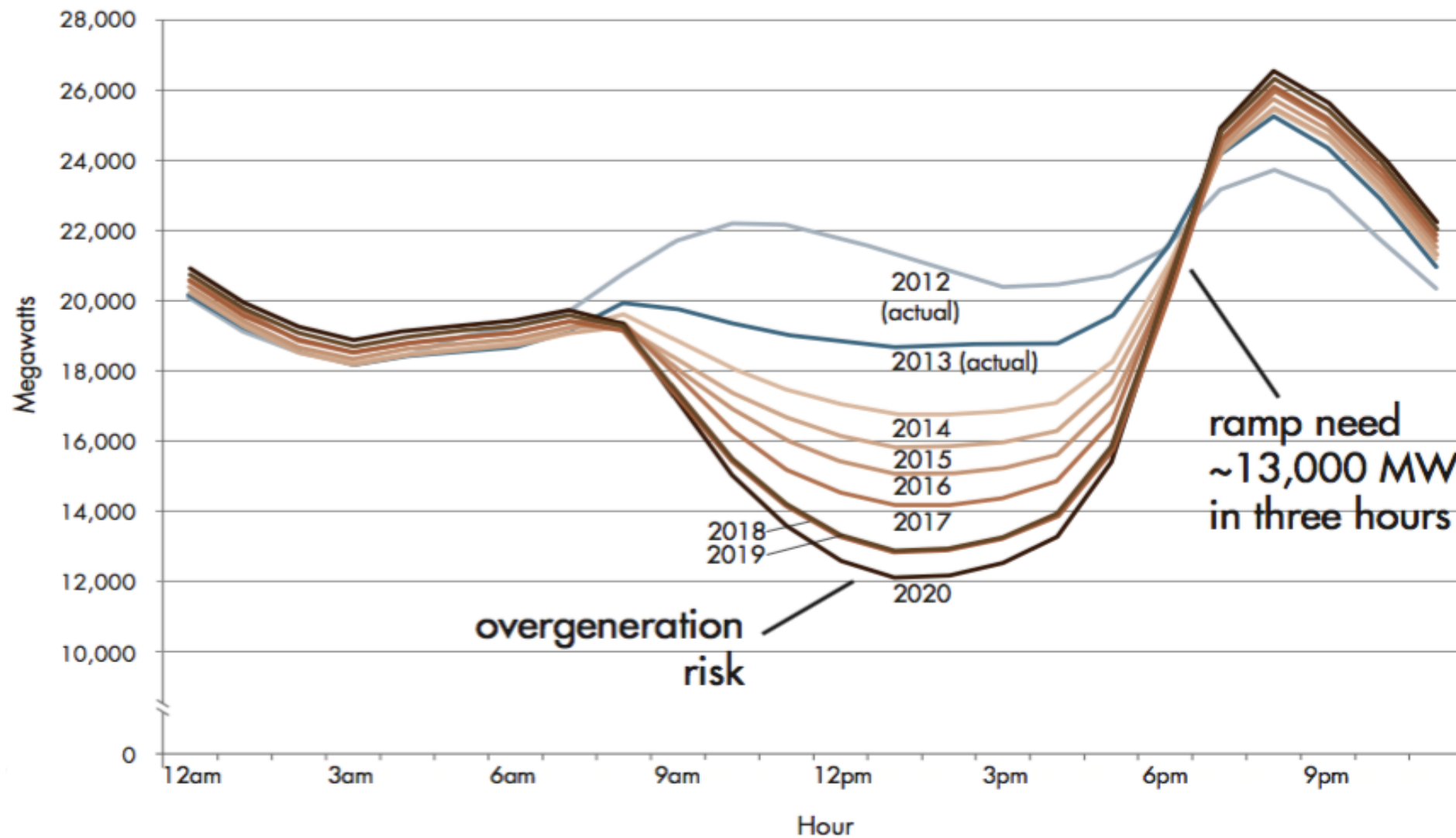

Backfeed condition at 46kV level in Hawaii

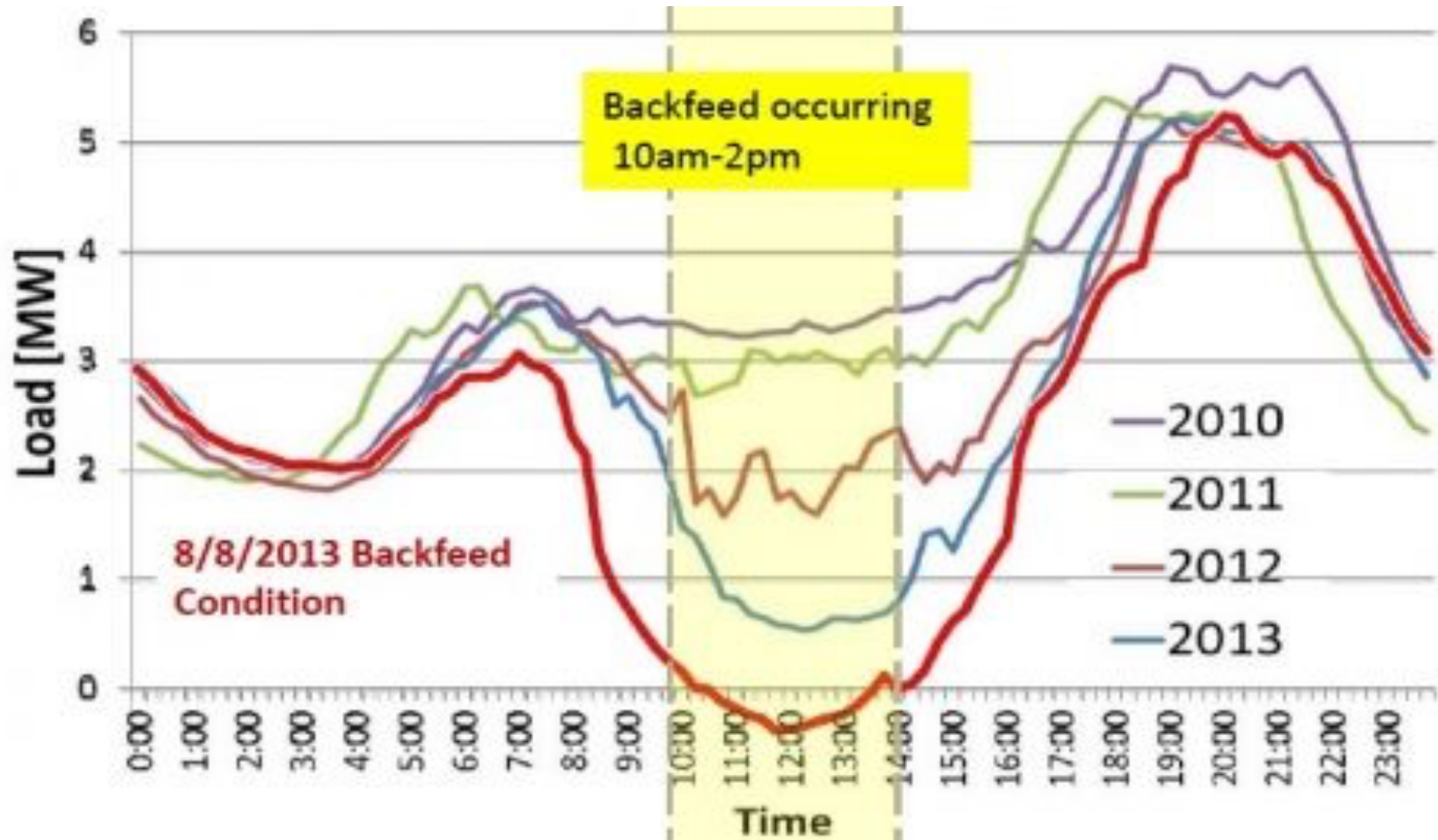

Simulation of a CSP plant

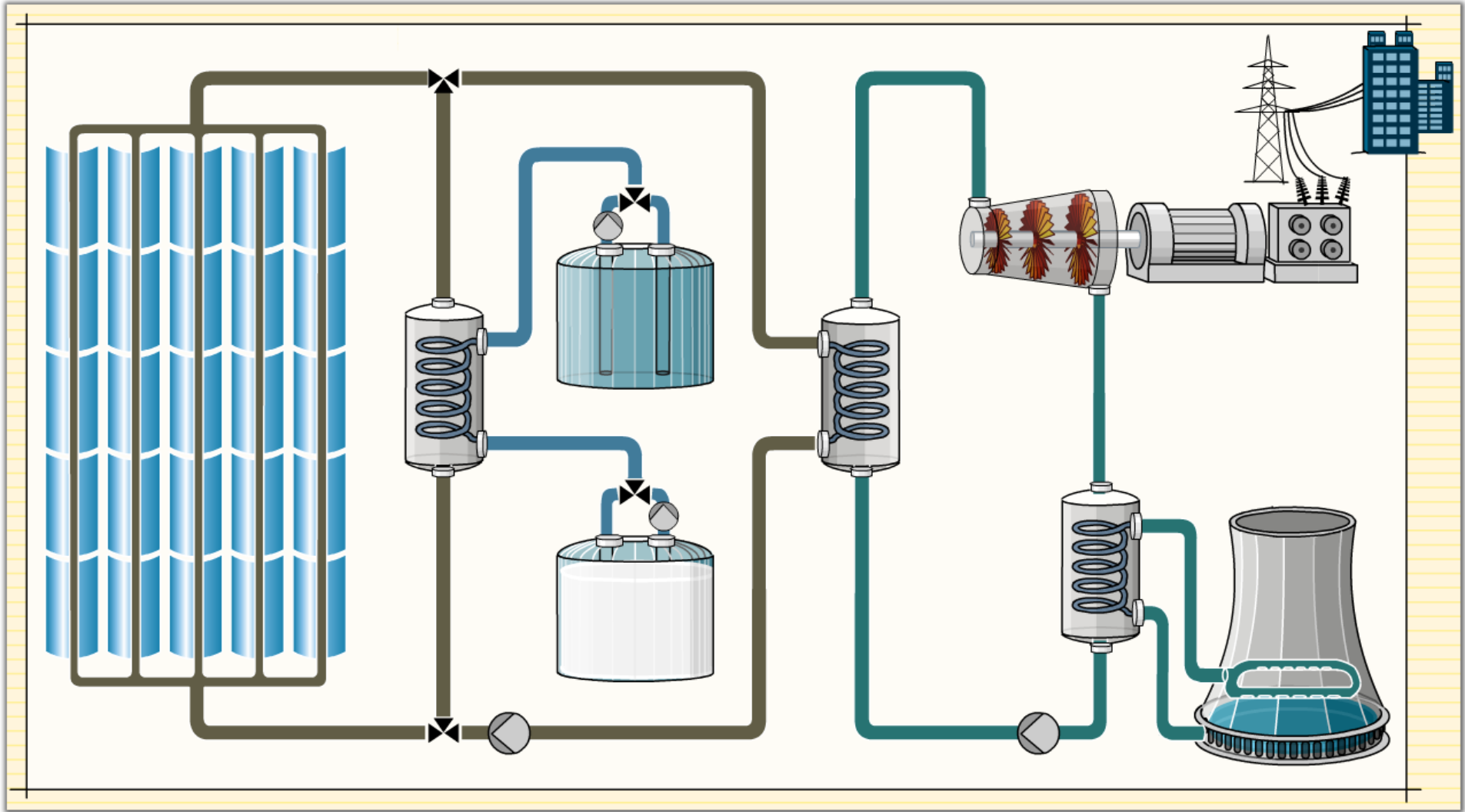

andasol_blue_engl.swf

Example of 75MW CSP generation during peak load (no storage, normal conditions)

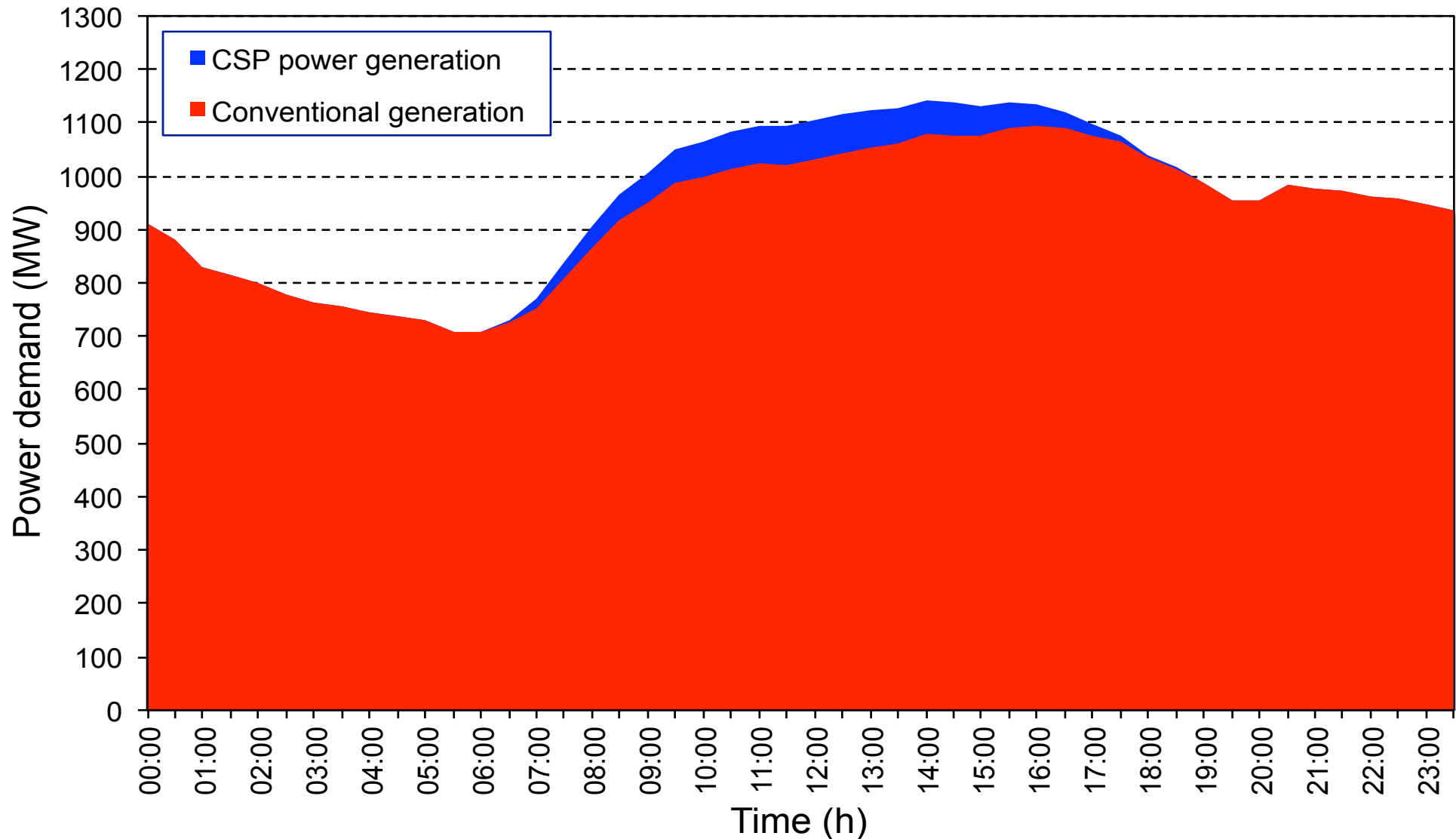

Example of 75MW CSP generation during peak load (no storage, with clouds)

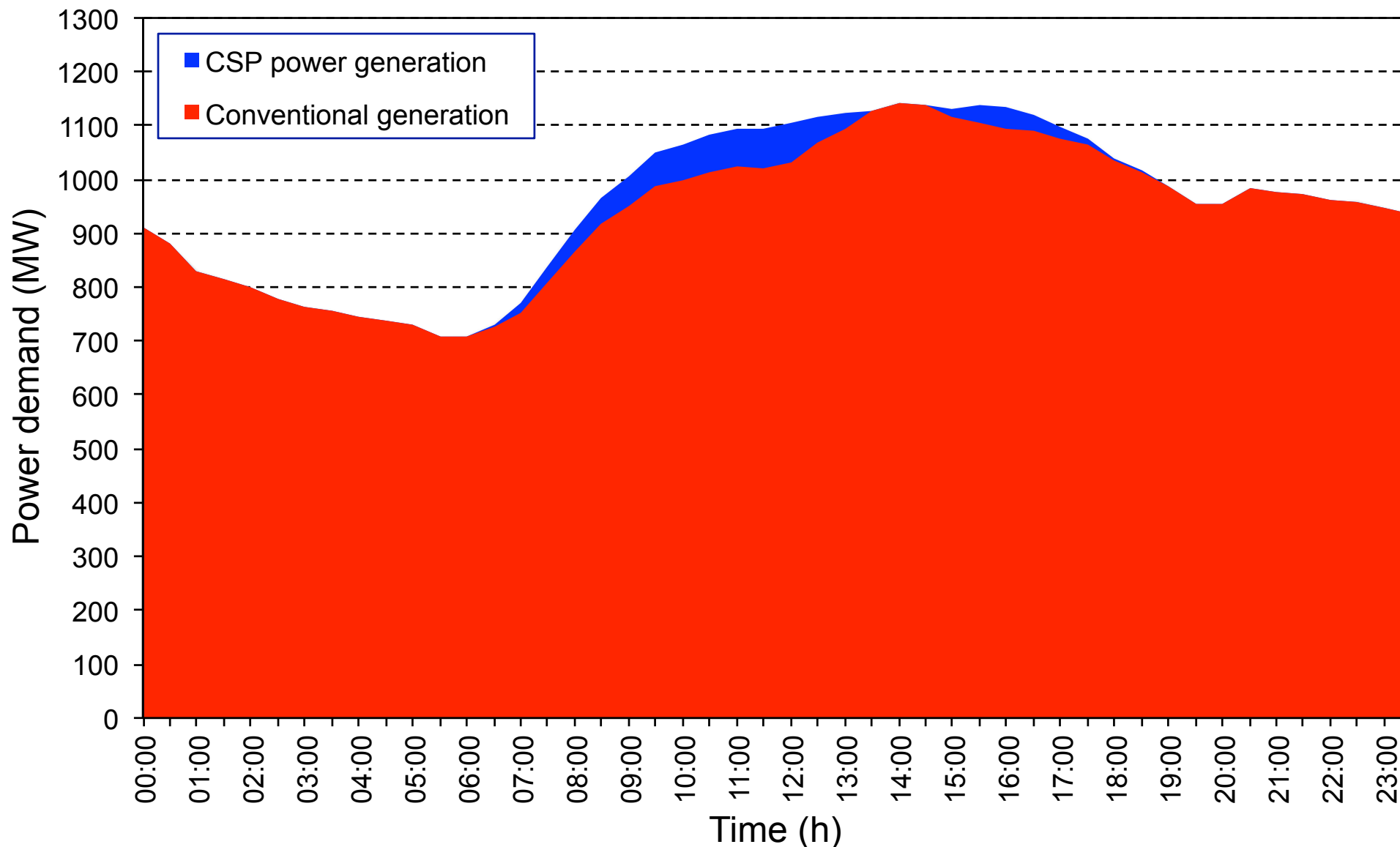

Example of 75MW CSP generation during peak load (6h storage, normal conditions)

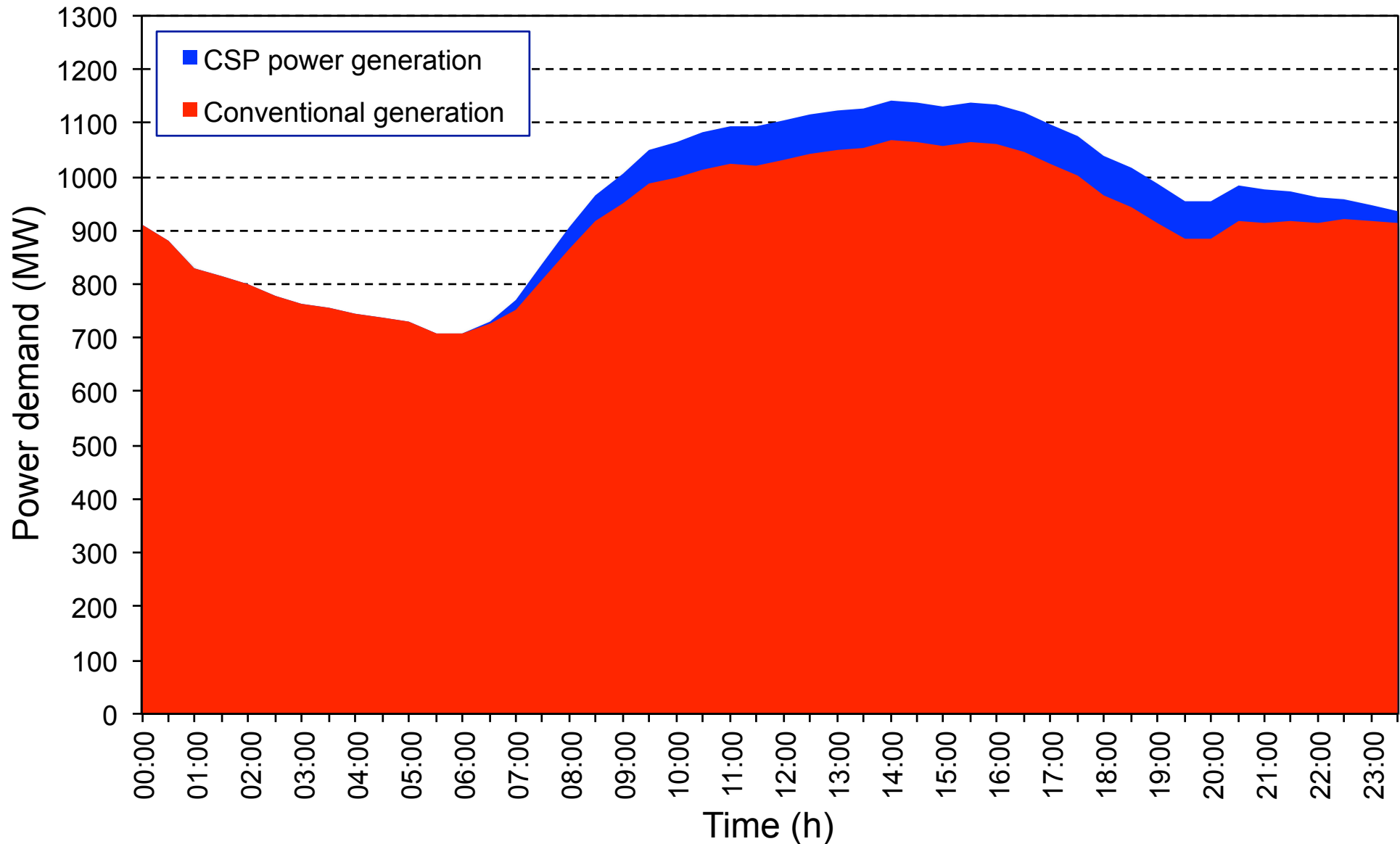

Example of 75MW CSP generation during peak load (6h storage, with clouds)

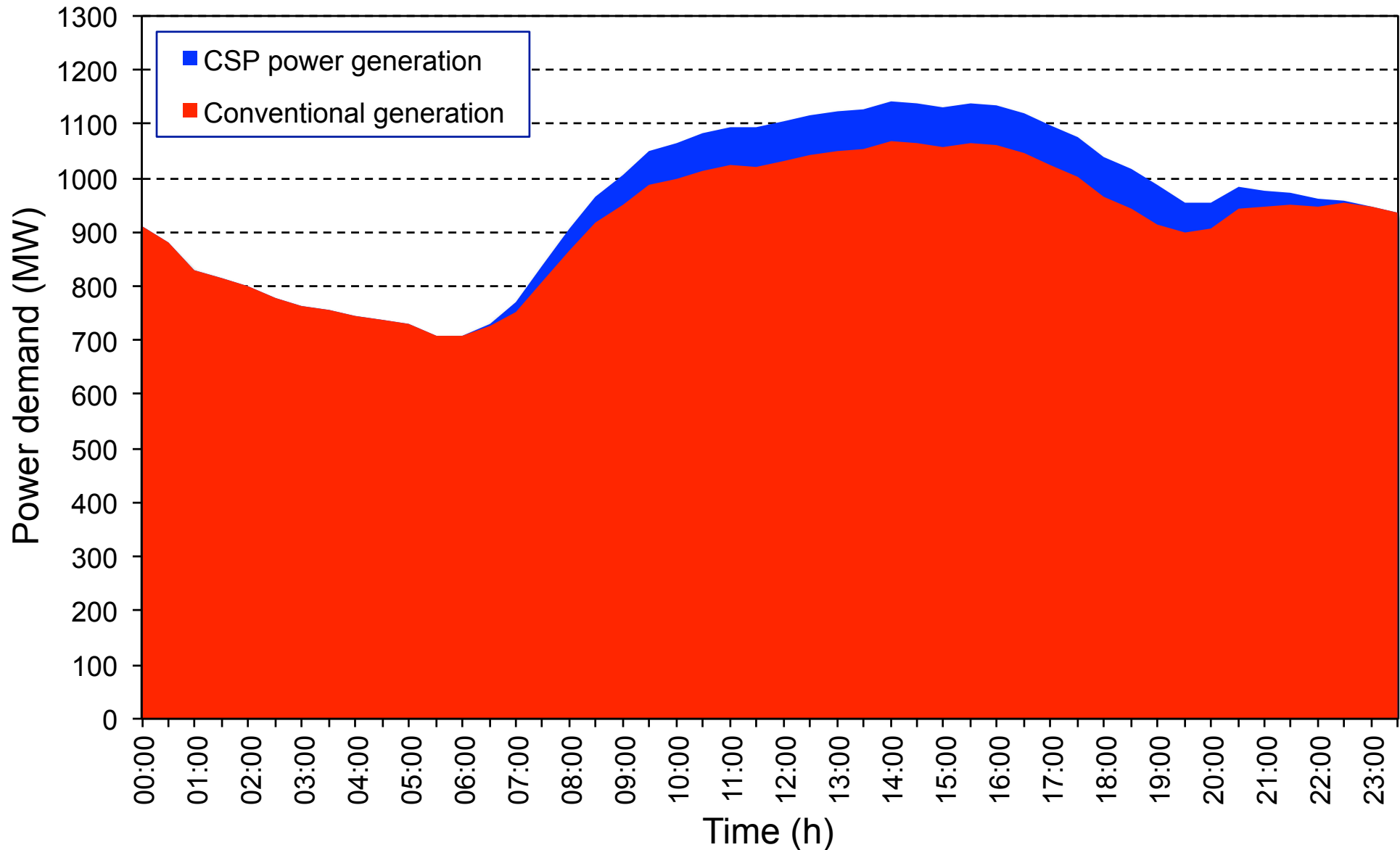

Operation and control

PS operation and control

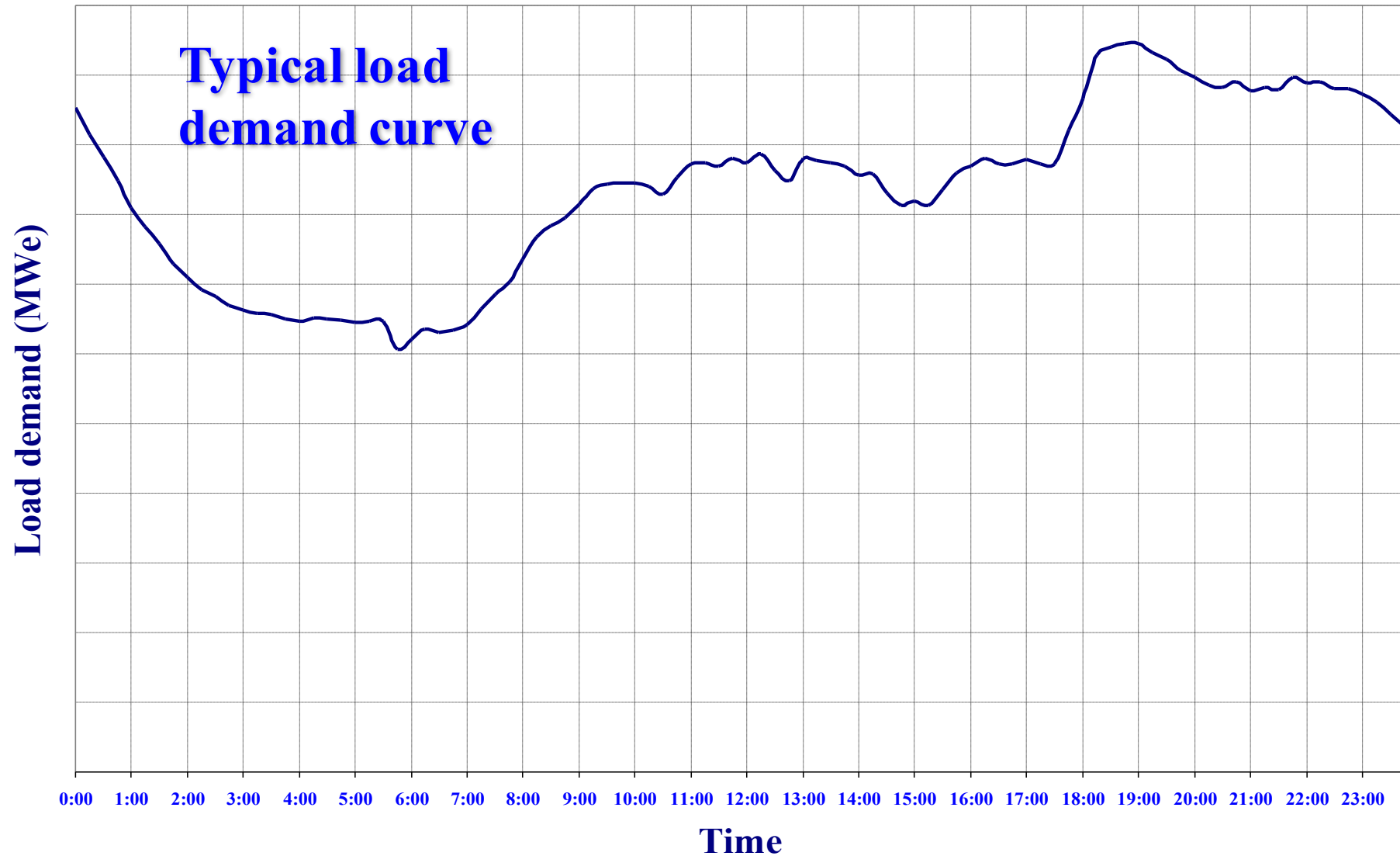

PS operation and control

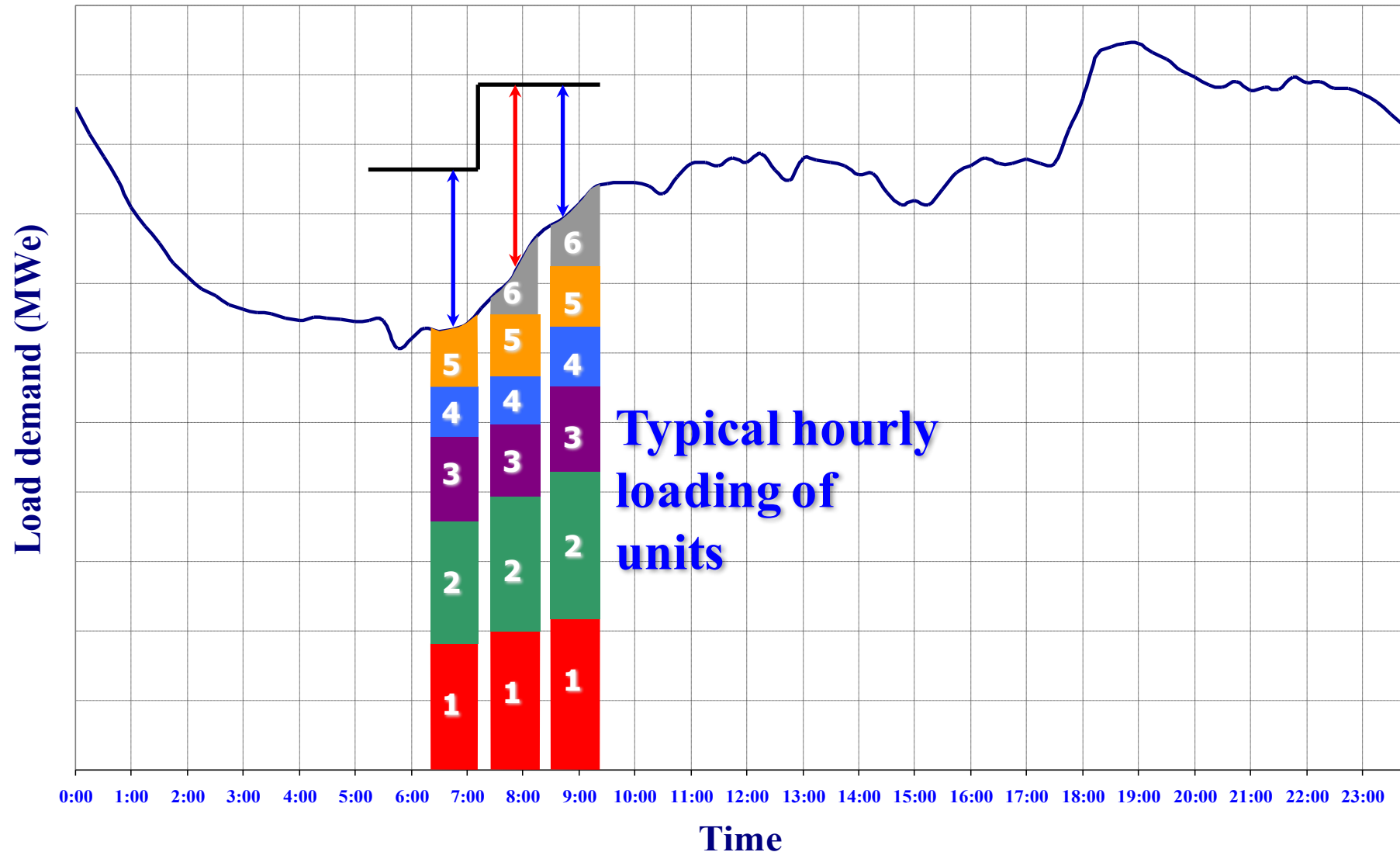

Key operational parameters

- **Power balance: Generation must remain balanced with demand**
 - **Total generation (t) = Total demand (t) + Losses (t)**
- **System security**
 - **Equipment power flows must not exceed equipment ratings under normal or a single outage condition**

Use of generators burning fuel

- The economic dispatch problem
- The unit commitment problem

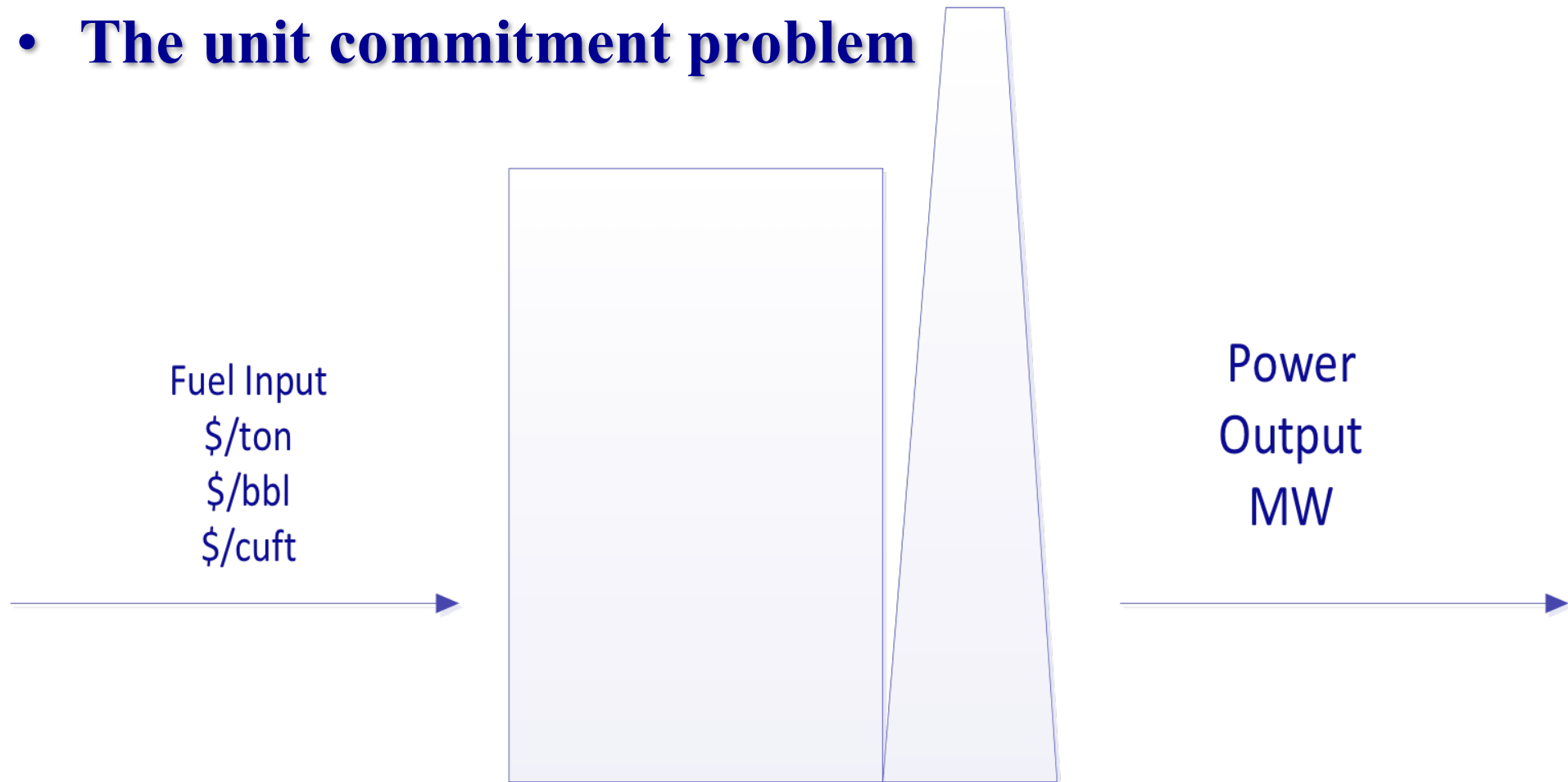

Multiple generators

- How do we allocate MW output to the generators to minimize the total cost of operating all generators

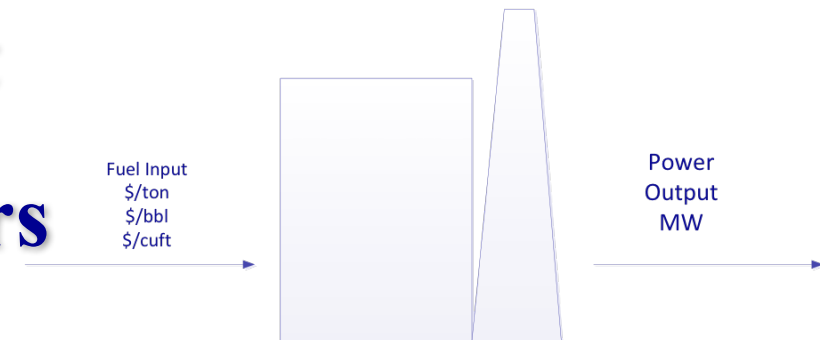
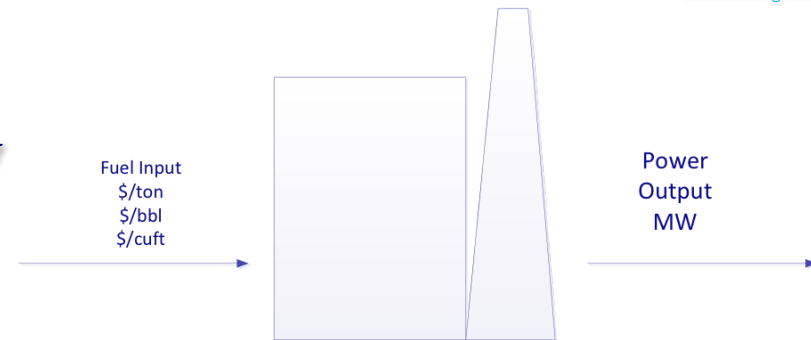

THE ECONOMIC DISPATCH PROBLEM

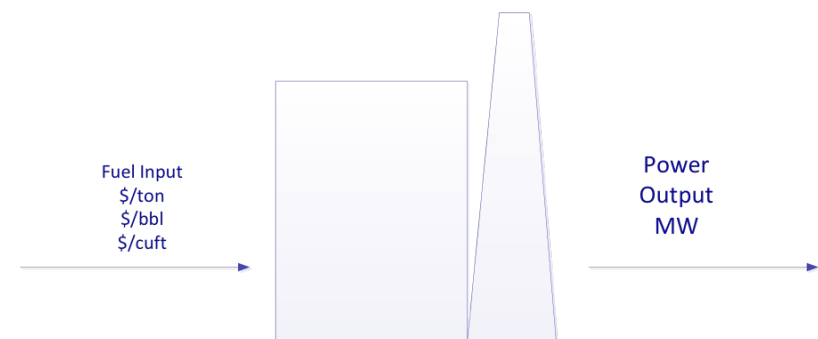

Scheduling generation

- **How do we schedule generation units to meet hourly load**

THE UNIT COMMITMENT PROBLEM

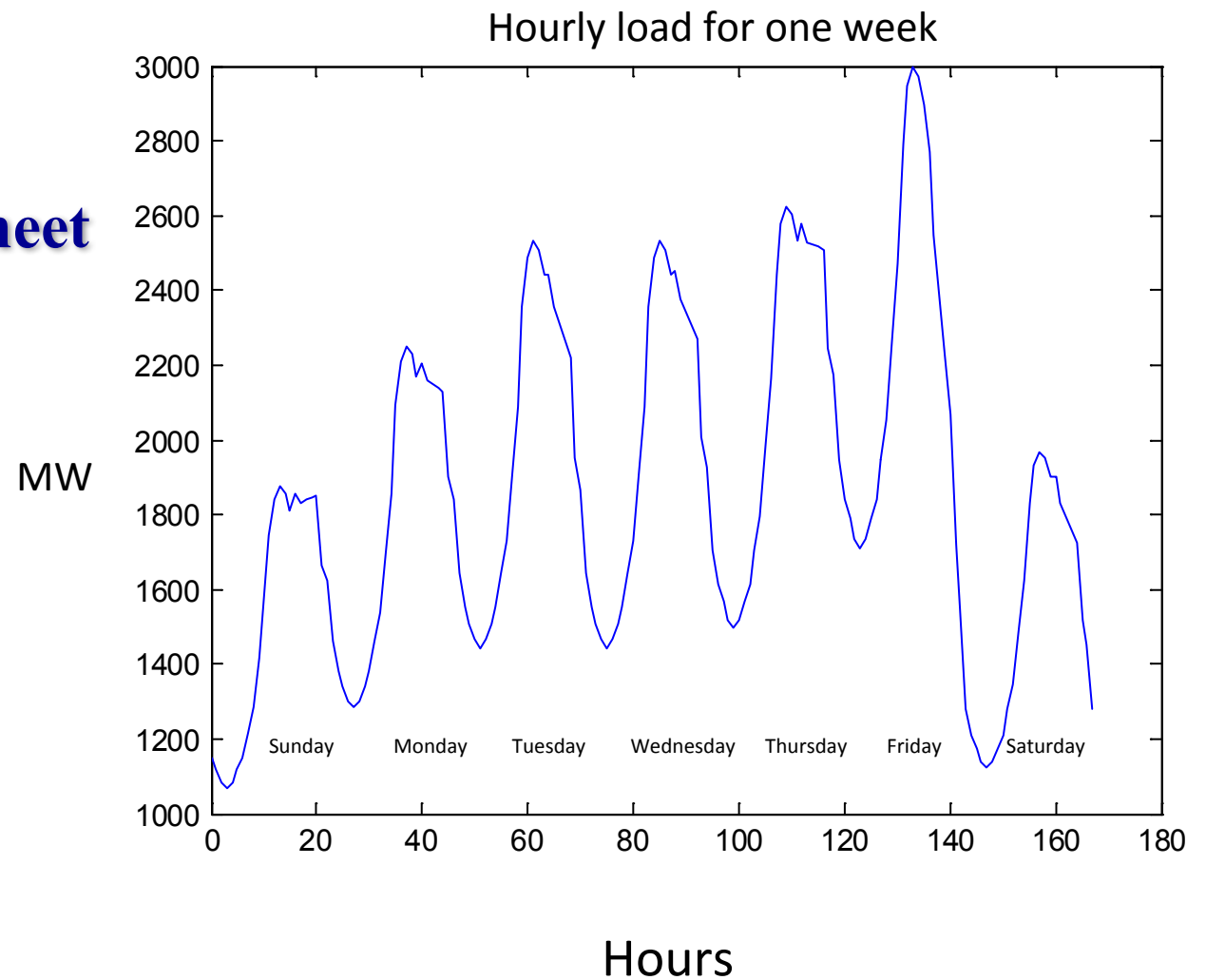

The economic dispatch problem

Small power generation system

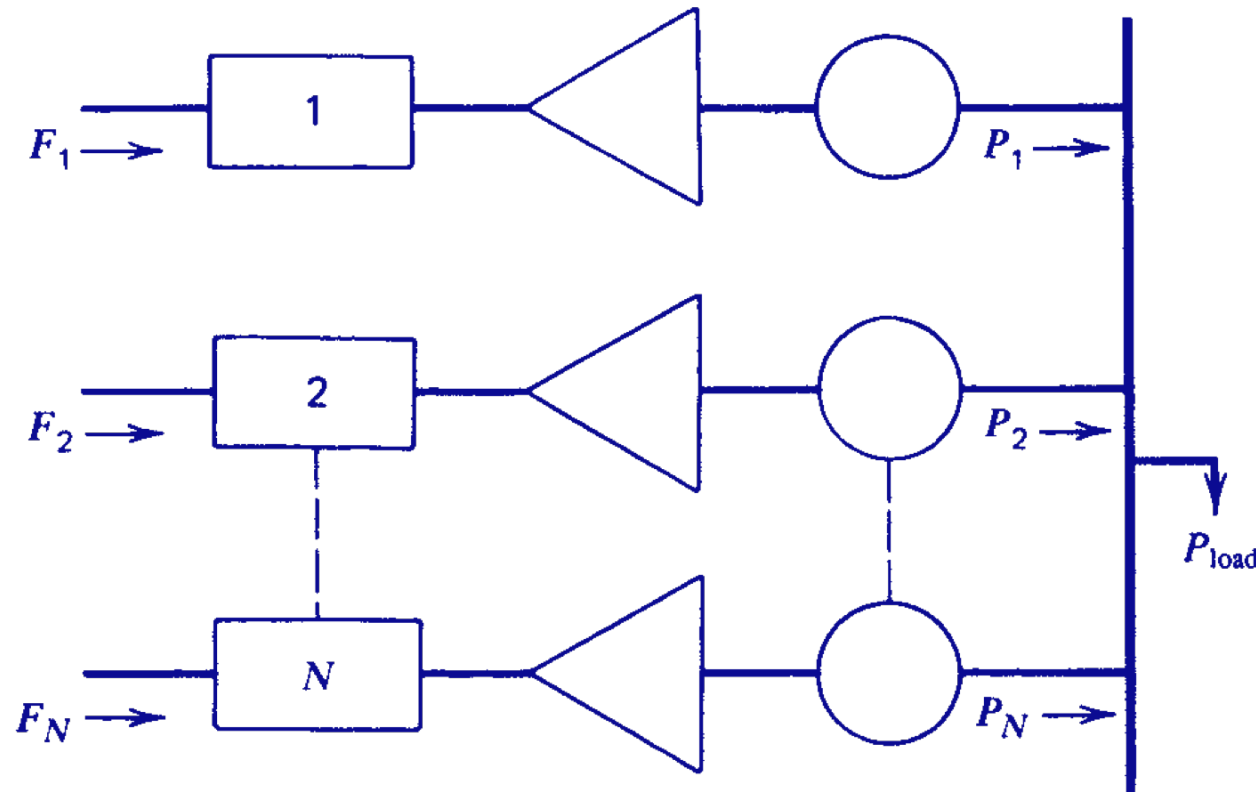

- N thermal-generating units connected to a single busbar serving a received electrical load P_{load} in MW
- Input to each unit, F , represents the cost rate in \$/h
- Output of each unit, P_i , is the electrical power generated by that particular unit in MW

Economic dispatch methods

- **Lagrange multipliers method**
- **Linear programming method**
- **Dynamic programming method**

Lagrange multipliers method

Objective function

Minimize

$$F_T = F_1 + F_2 + F_3 + \dots + F_{Ngen}$$

$$= \sum_{i=1}^{Ngen} F_i(P_i)$$

subject to

$$\phi = 0 = P_{load} - \sum_{i=1}^{Ngen} P_i$$

Note: any transmission losses are neglected

Constraint optimization problem

Can be solved involving the Lagrange function

$$\mathcal{L} = F_T + \lambda \phi$$

Solution: 1st Derivative should be equal to zero

$$\frac{\partial \mathcal{L}}{\partial P_i} = \frac{dF_i(P_i)}{dP_i} - \lambda = 0$$

or

$$0 = \frac{dF_i}{dP_i} - \lambda$$

Minimum cost operating condition

$$\frac{dF_i}{dP_i} = \lambda$$

- **For a minimum cost operating condition the incremental cost rates of all units should be equal to an unknown value λ**

Mathematical statement of the optimum

Solve

$$\frac{dF_i}{dP_i} = \lambda$$

subject to

$$P_{i,\min} \leq P_i \leq P_{i,\max}$$

$$\sum_{i=1}^N P_i = P_{\text{load}}$$

Full conditions and inequalities for minimum cost operating condition

Linear programming method

- Express the nonlinear input-output or cost functions as a set of linear functions

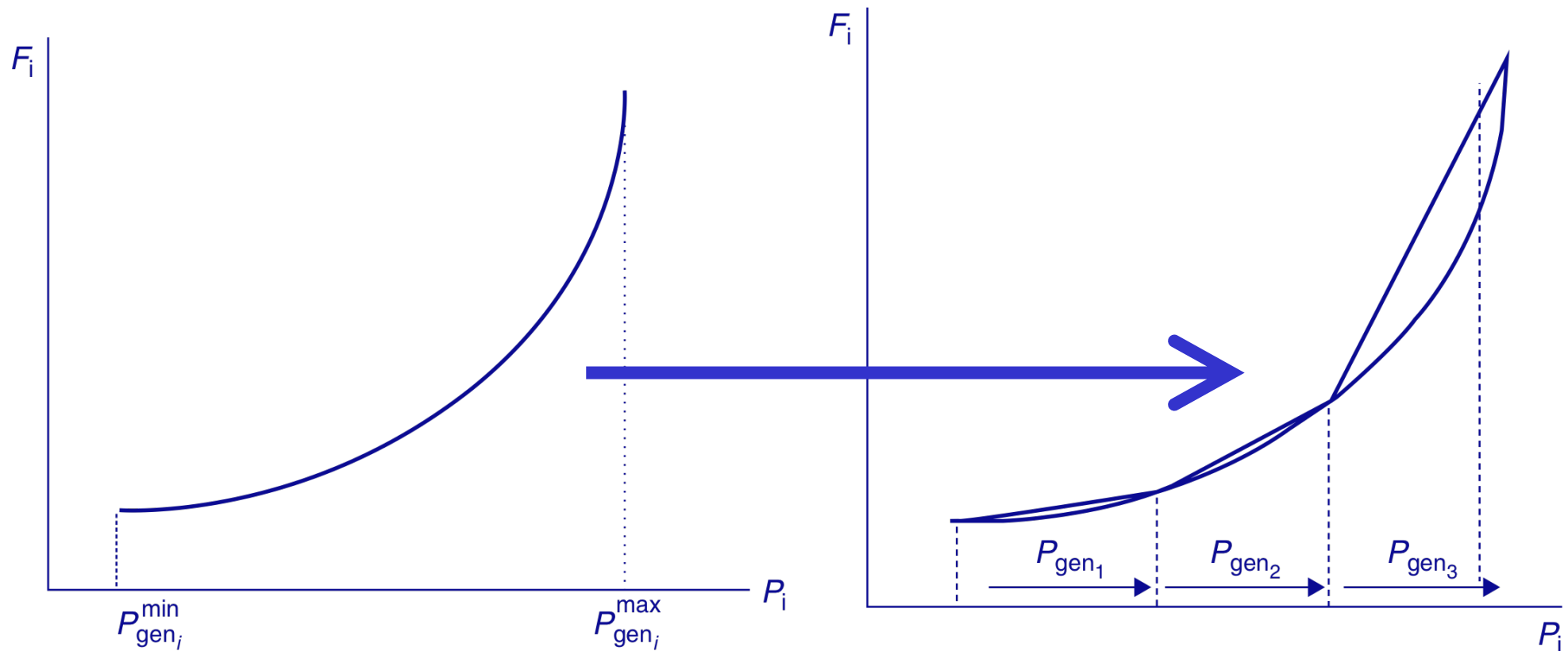

LP formulation

$$F_i(Pgen_i) = F_i(Pgen_i^{\min}) + s_{i1}Pgen_{i1} + s_{i2}Pgen_{i2} + s_{i3}Pgen_{i3}$$

where

$$0 \leq Pgen_{ik} \leq Pgen_{ik}^{\max} \text{ for } k=1,2,3$$

also

$$Pgen_i = Pgen_i^{\min} + Pgen_{i1} + Pgen_{i2} + Pgen_{i3}$$

and

$$s_{ik} = \frac{F_i(Pgen_{ik+1}) - F_i(Pgen_{ik})}{(Pgen_{ik+1} - Pgen_{ik})}$$

- k = index for segments
- s = slope

LP economic dispatch

$$\text{Minimize } \sum_{i=1}^{Ngen} (F_i(Pgen_i^{\min}) + s_{i1}Pgen_{i1} + s_{i2}Pgen_{i2} + s_{i3}Pgen_{i3})$$

$$0 \leq Pgen_{ik} \leq Pgen_{ik}^{\max} \text{ for } k=1,2,3,\dots \text{ for all generators } i=1 \dots Ngen$$

also

$$P_i = P_i^{\min} + Pgen_{i1} + Pgen_{i2} + Pgen_{i3} \text{ for all generators } i = 1 \dots Ngen$$

subject to

$$\sum_{i=1}^{Ngen} P_i = P_{load}$$

Dynamic Programming method

- **Number of steam admission valves:**
 - open in sequence
 - obtain ever-increasing output
- **Input-output characteristic is nonconvex** (e.g., first derivative is not monotonically increasing)
- **If nonconvex input-output curves are to be used then optimum dispatch uses DP**

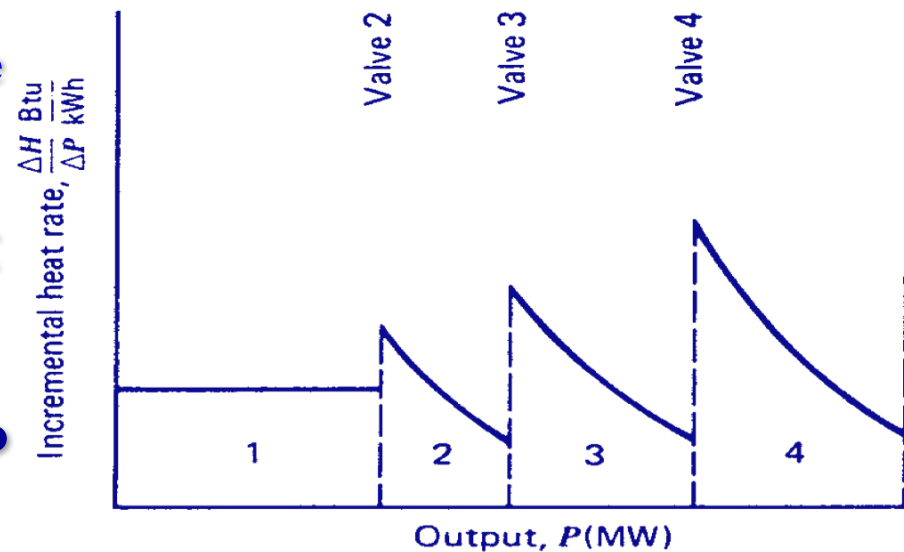
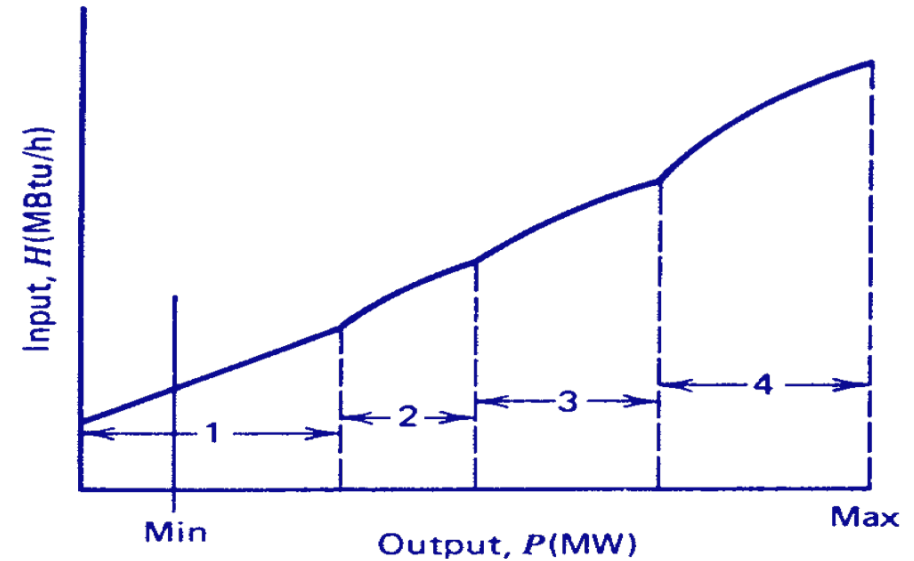

ED including transmission losses

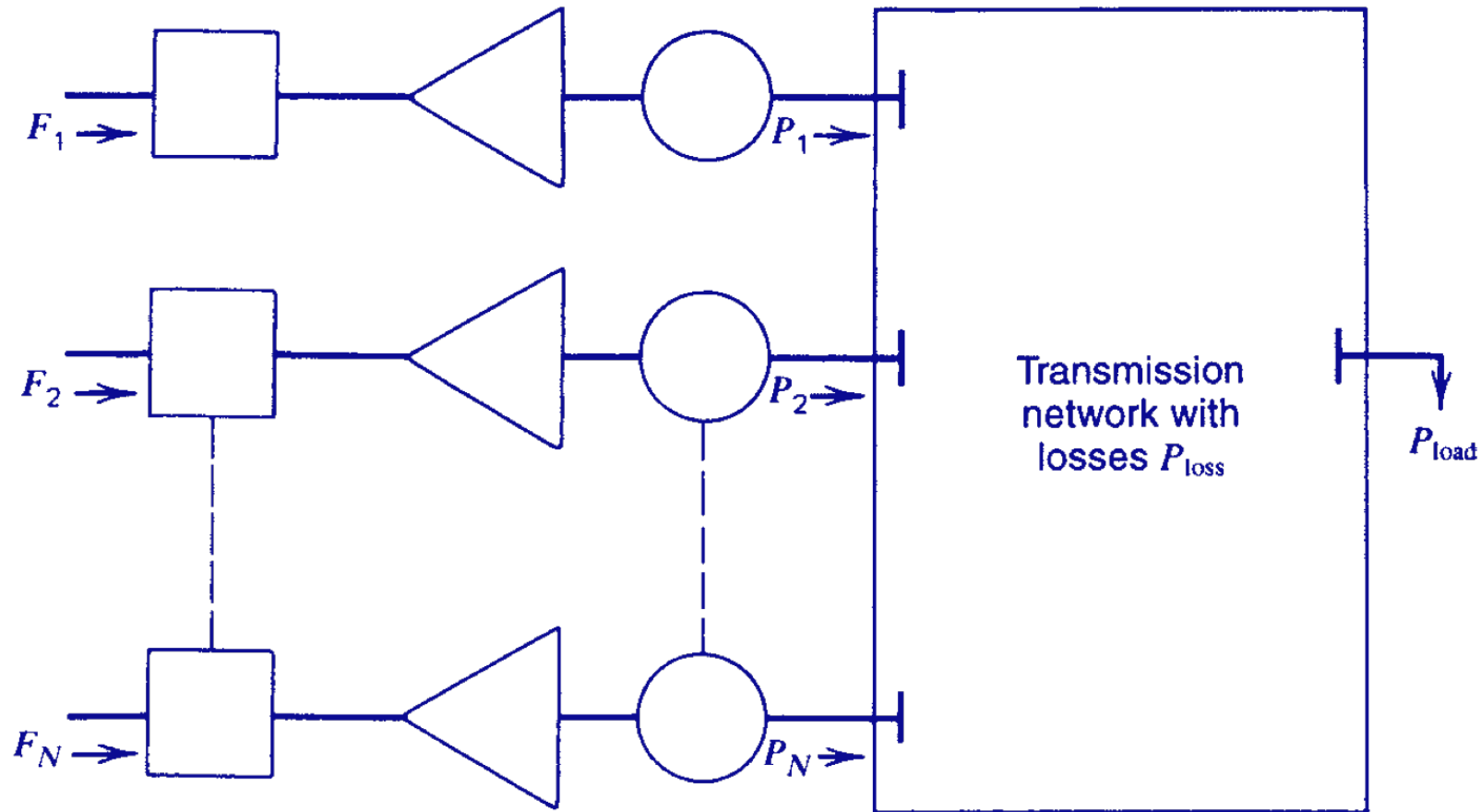

$$P_{\text{load}} + P_{\text{loss}} - \sum_{i=1}^{N_{\text{gen}}} P_i = \phi = 0$$

The unit commitment problem

Basis of unit commitment

- **“Commit” a generating unit = “Turn on” a generating unit**
 - **bring the unit up to speed**
 - **synchronize the unit to the system**
 - **connect the unit so it can deliver power to the network**
- **Commit enough units to cover the maximum system load and leave them running?**

Unit commitment vs Economic dispatch

- **Economic dispatch problem assumes that there are N_{gen} units already connected to the system**
 - **the purpose is to find the optimum operating policy for these N_{gen} units**
- **Unit commitment problem is more complex**
- **The solution procedures of unit commitment problem involve the economic dispatch problem as a subproblem**

Unit commitment vs Economic dispatch

- **On unit commitment problem assume:**
 - available N_{gen} units
 - available forecast of the demand to be served
- **Given that there are a number of subsets of the complete set of N_{gen} generating units that would satisfy the expected demand, which of these subsets should be used in order to provide the minimum operating cost?**
- **This unit commitment problem may be extended over some period of time, such as the 24 h of a day or the 168 h of a week**

Example 1

Determine what unit or combination of the available units below should be used in order to supply a load of 550MW most economically

Unit 1: Min = 150 MW

Max = 600 MW

$$H_1 = 510.0 + 7.2P_1 + 0.00142P_1^2 \text{ MBtu/h}$$

Fuel cost₁ = 1.1\$/Mbtu

Fuel cost₂ = 1.0\$/Mbtu

Fuel cost₃ = 1.2\$/MBtu

Unit 2: Min = 100 MW

Max = 400 MW

$$H_2 = 310.0 + 7.85P_2 + 0.00194P_2^2 \text{ MBtu/h}$$

Unit 3: Min = 50 MW

Max = 200 MW

$$H_3 = 78.0 + 7.97P_3 + 0.00482P_3^2 \text{ MBtu/h}$$

Example 1: Solution

- **Try all combinations of the three units**
- **Some combinations will be infeasible**
 - **if the sum of all maximum MW for the units committed is less than the load or**
 - **if the sum of all minimum MW for the units committed is greater than the load**
- **For each feasible combination, the units will be dispatched using the ED techniques**

Example 1: Solution

Unit 1	Unit 2	Unit 3	Max Gen	Min Gen	P_1	P_2	P_3	F_1	F_2	F_3	Total Gen Cost $F_1 + F_2 + F_3$
Off	Off	Off	0	0							Infeasible
Off	Off	On	200	50							Infeasible
Off	On	Off	400	100							Infeasible
Off	On	On	600	150	0	400	150	0	3760	1658	5418
On	Off	Off	600	150	550	0	0	5389	0	0	5389
On	Off	On	800	200	500	0	50	4911	0	586	5497
On	On	Off	1000	250	295	255	0	3030	2440	0	5471
On	On	On	1200	300	267	233	50	2787	2244	586	5617

Optimum commitment is to only run unit 1, the most economic unit !!!

Constraints in unit commitment

- **Simple constraint: Enough units are committed to supply the load**
- **Important constraints:**
 - **Spinning reserve constraints**
 - **Thermal unit constraints**
 - **Must run constraints**
 - **Fuel constraints**
 - **Hydro constraints**

Spinning reserve constraint

- **Total amount of generation available from all units synchronized (i.e., spinning) on the system, minus the present load and losses being supplied**
- **Spinning reserve objective:**
 - **the loss of one or more units does not cause too far a drop in system frequency**
- **If one unit is lost, there must be ample reserve on the other units to make up for the loss in a specified time period**

Solution algorithms

- **Priority-list method**
- **Lagrange relaxation (LR)**
- **Dynamic programming (DP)**
- **Mixed integer linear programming (MILP)**

LR algorithm

The Unit commitment Schedule

Hour	Load MW	Total Gen	Gen 1	Gen 2	Gen 3	Gen 4	Gen 5	Gen 6	Gen 7	Gen 8	Gen 9	Gen 10	Gen 11	Gen 12	Gen 13	Gen 14	Gen 15	Gen 16	Gen 17	Gen 18	Sum Cost
1	1151	1151	800.0	351.3	0.0	0.0	0.0	0.0	0.0	0.0	0.0	0.0	0.0	0.0	0.0	0.0	0.0	0.0	0.0	0.0	6205
2	1118	1118	800.0	318.4	0.0	0.0	0.0	0.0	0.0	0.0	0.0	0.0	0.0	0.0	0.0	0.0	0.0	0.0	0.0	0.0	5963
3	1086	1086	800.0	285.5	0.0	0.0	0.0	0.0	0.0	0.0	0.0	0.0	0.0	0.0	0.0	0.0	0.0	0.0	0.0	0.0	5726
4	1069	1069	800.0	269.1	0.0	0.0	0.0	0.0	0.0	0.0	0.0	0.0	0.0	0.0	0.0	0.0	0.0	0.0	0.0	0.0	5609
5	1086	1086	800.0	285.5	0.0	0.0	0.0	0.0	0.0	0.0	0.0	0.0	0.0	0.0	0.0	0.0	0.0	0.0	0.0	0.0	5726
6	1118	1118	800.0	318.4	0.0	0.0	0.0	0.0	0.0	0.0	0.0	0.0	0.0	0.0	0.0	0.0	0.0	0.0	0.0	0.0	5963
7	1151	1151	800.0	351.3	0.0	0.0	0.0	0.0	0.0	0.0	0.0	0.0	0.0	0.0	0.0	0.0	0.0	0.0	0.0	0.0	6205
8	1217	1217	800.0	417.1	0.0	0.0	0.0	0.0	0.0	0.0	0.0	0.0	0.0	0.0	0.0	0.0	0.0	0.0	0.0	0.0	6701
9	1283	1283	800.0	482.9	0.0	0.0	0.0	0.0	0.0	0.0	0.0	0.0	0.0	0.0	0.0	0.0	0.0	0.0	0.0	0.0	7214
10	1414	1414	800.0	614.5	0.0	0.0	0.0	0.0	0.0	0.0	0.0	0.0	0.0	0.0	0.0	0.0	0.0	0.0	0.0	0.0	8292
11	1546	1546	800.0	636.7	109.4	0.0	0.0	0.0	0.0	0.0	0.0	0.0	0.0	0.0	0.0	0.0	0.0	0.0	0.0	0.0	9406
12	1743	1743	800.0	746.3	197.1	0.0	0.0	0.0	0.0	0.0	0.0	0.0	0.0	0.0	0.0	0.0	0.0	0.0	0.0	0.0	11136
13	1842	1842	800.0	800.0	242.1	0.0	0.0	0.0	0.0	0.0	0.0	0.0	0.0	0.0	0.0	0.0	0.0	0.0	0.0	0.0	12033
14	1875	1875	800.0	800.0	275.0	0.0	0.0	0.0	0.0	0.0	0.0	0.0	0.0	0.0	0.0	0.0	0.0	0.0	0.0	0.0	12339
15	1859	1859	800.0	800.0	258.6	0.0	0.0	0.0	0.0	0.0	0.0	0.0	0.0	0.0	0.0	0.0	0.0	0.0	0.0	0.0	12186
16	1809	1809	800.0	782.9	226.3	0.0	0.0	0.0	0.0	0.0	0.0	0.0	0.0	0.0	0.0	0.0	0.0	0.0	0.0	0.0	11732
17	1854	1854	800.0	800.0	254.4	0.0	0.0	0.0	0.0	0.0	0.0	0.0	0.0	0.0	0.0	0.0	0.0	0.0	0.0	0.0	12147
18	1831	1831	800.0	794.8	235.8	0.0	0.0	0.0	0.0	0.0	0.0	0.0	0.0	0.0	0.0	0.0	0.0	0.0	0.0	0.0	11928
19	1839	1839	800.0	799.3	239.5	0.0	0.0	0.0	0.0	0.0	0.0	0.0	0.0	0.0	0.0	0.0	0.0	0.0	0.0	0.0	12003
20	1845	1845	800.0	800.0	245.4	0.0	0.0	0.0	0.0	0.0	0.0	0.0	0.0	0.0	0.0	0.0	0.0	0.0	0.0	0.0	12064
21	1850	1850	800.0	800.0	250.3	0.0	0.0	0.0	0.0	0.0	0.0	0.0	0.0	0.0	0.0	0.0	0.0	0.0	0.0	0.0	12109
22	1664	1664	800.0	702.5	162.0	0.0	0.0	0.0	0.0	0.0	0.0	0.0	0.0	0.0	0.0	0.0	0.0	0.0	0.0	0.0	10433
23	1623	1623	800.0	679.6	143.7	0.0	0.0	0.0	0.0	0.0	0.0	0.0	0.0	0.0	0.0	0.0	0.0	0.0	0.0	0.0	10073
24	1461	1461	800.0	580.5	80.0	0.0	0.0	0.0	0.0	0.0	0.0	0.0	0.0	0.0	0.0	0.0	0.0	0.0	0.0	0.0	8683
25	1382	1382	800.0	581.6	0.0	0.0	0.0	0.0	0.0	0.0	0.0	0.0	0.0	0.0	0.0	0.0	0.0	0.0	0.0	0.0	8016
26	1342	1342	800.0	542.1	0.0	0.0	0.0	0.0	0.0	0.0	0.0	0.0	0.0	0.0	0.0	0.0	0.0	0.0	0.0	0.0	7690
27	1303	1303	800.0	502.6	0.0	0.0	0.0	0.0	0.0	0.0	0.0	0.0	0.0	0.0	0.0	0.0	0.0	0.0	0.0	0.0	7371
28	1283	1283	800.0	482.9	0.0	0.0	0.0	0.0	0.0	0.0	0.0	0.0	0.0	0.0	0.0	0.0	0.0	0.0	0.0	0.0	7214
29	1303	1303	800.0	502.6	0.0	0.0	0.0	0.0	0.0	0.0	0.0	0.0	0.0	0.0	0.0	0.0	0.0	0.0	0.0	0.0	7371
30	1342	1342	800.0	542.1	0.0	0.0	0.0	0.0	0.0	0.0	0.0	0.0	0.0	0.0	0.0	0.0	0.0	0.0	0.0	0.0	7690
31	1382	1382	800.0	581.6	0.0	0.0	0.0	0.0	0.0	0.0	0.0	0.0	0.0	0.0	0.0	0.0	0.0	0.0	0.0	0.0	8016
32	1461	1461	800.0	580.5	80.0	0.0	0.0	0.0	0.0	0.0	0.0	0.0	0.0	0.0	0.0	0.0	0.0	0.0	0.0	0.0	8683
33	1539	1539	800.0	633.0	106.4	0.0	0.0	0.0	0.0	0.0	0.0	0.0	0.0	0.0	0.0	0.0	0.0	0.0	0.0	0.0	9350
34	1697	1697	800.0	720.8	176.6	0.0	0.0	0.0	0.0	0.0	0.0	0.0	0.0	0.0	0.0	0.0	0.0	0.0	0.0	0.0	10724
35	1855	1855	800.0	800.0	255.3	0.0	0.0	0.0	0.0	0.0	0.0	0.0	0.0	0.0	0.0	0.0	0.0	0.0	0.0	0.0	12155
36	2092	2092	800.0	762.3	209.8	80.0	60.0	60.0	0.0	0.0	0.0	0.0	0.0	0.0	60.0	60.0	0.0	0.0	0.0	0.0	15019
37	2211	2211	800.0	800.0	290.5	80.0	60.0	60.0	0.0	0.0	0.0	0.0	0.0	0.0	60.0	60.0	0.0	0.0	0.0	0.0	16110

DP algorithm

HOURL: 1 DEMAND: 900.0 MW F-COST: 13472.9 £

UNITS	ON/OFF	GENERATION	MIN MW	MAX MW	ST-UP Cost	PROD.COST
1	0	0.0	0.0	0.0	0.0	0.0
2	1	60.0	60.0	250.0	0.0	1665.6
3	1	150.0	75.0	300.0	0.0	3303.7
4	0	0.0	0.0	0.0	0.0	0.0
5	1	80.0	25.0	80.0	350.0	1048.2
6	1	250.0	60.0	250.0	0.0	2835.6
7	1	300.0	75.0	300.0	0.0	3303.7
8	1	60.0	20.0	60.0	0.0	966.0
TOTAL:	6	900.0	315.0	1240.0	350.0	13122.9

HOURL: 2 DEMAND: 1060.0 MW F-COST: 29394.9 £

UNITS	ON/OFF	GENERATION	MIN MW	MAX MW	ST-UP Cost	PROD.COST
1	0	0.0	0.0	0.0	0.0	0.0
2	1	70.0	60.0	250.0	0.0	1845.6
3	1	300.0	75.0	300.0	0.0	5922.7
4	0	0.0	0.0	0.0	0.0	0.0
5	1	80.0	25.0	80.0	0.0	1048.2
6	1	250.0	60.0	250.0	0.0	2835.6
7	1	300.0	75.0	300.0	0.0	3303.7
8	1	60.0	20.0	60.0	0.0	966.0
TOTAL:	6	1060.0	315.0	1240.0	0.0	15921.9

HOURL: 3 DEMAND: 1200.0 MW F-COST: 47836.8 £

UNITS	ON/OFF	GENERATION	MIN MW	MAX MW	ST-UP Cost	PROD.COST
1	0	0.0	0.0	0.0	0.0	0.0
2	1	210.0	60.0	250.0	0.0	4365.6
3	1	300.0	75.0	300.0	0.0	5922.7
4	0	0.0	0.0	0.0	0.0	0.0
5	1	80.0	25.0	80.0	0.0	1048.2
6	1	250.0	60.0	250.0	0.0	2835.6
7	1	300.0	75.0	300.0	0.0	3303.7
8	1	60.0	20.0	60.0	0.0	966.0