



Keynote Speech

Development of energy strategies for sustainable future

Dr. Andreas Poulikkas

Ph.D, D.Tech, FIET

Chairman, Cyprus Energy Regulatory Authority

andreas.poulikkas@eecei.cut.ac.cy

Contents

- **EU energy strategy**
 - 2020, 2030, 2050
- **Challenges in electricity markets**
 - RES integration
 - NG and storage
- **Modeling for optimum large scale integration of RES**
 - Simulation of RES operation
 - Integration of storage

EU energy strategy

2020, 2030, 2050

Future energy systems

- **Climate change**

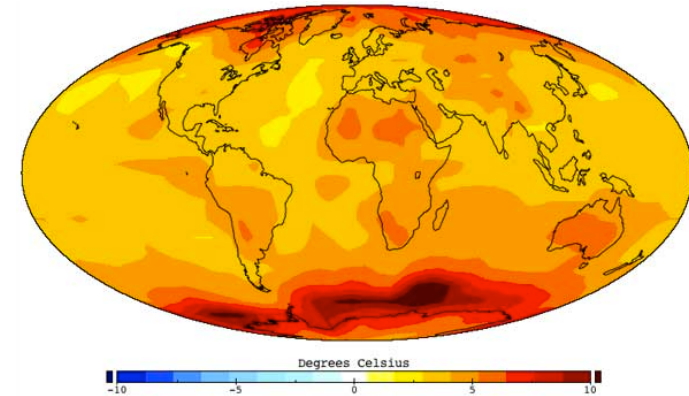

- **Third energy revolution**

- **Future energy economics**

EU energy objectives

- **greenhouse gas reduction**
- **sustainable production and consumption**
- **competition in electricity and natural gas markets**
- **security of supply**

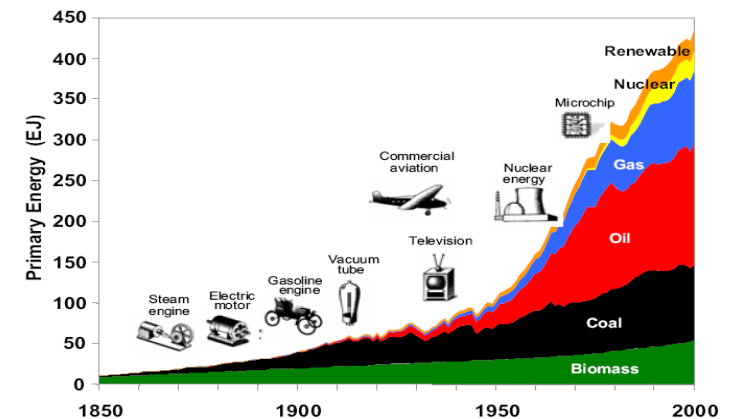

EU medium and long term targets

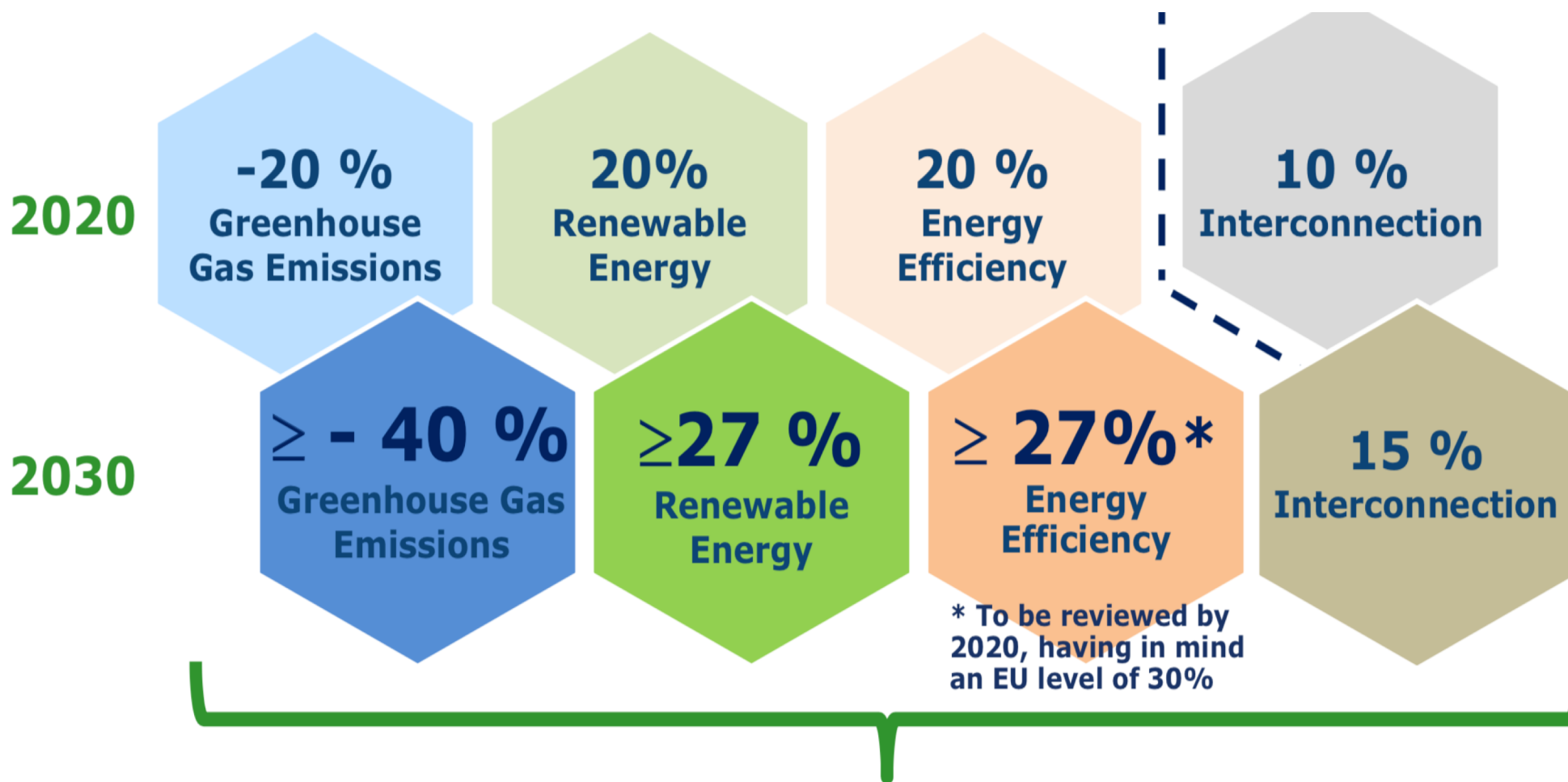

New governance system + indicators

2050 -80% Greenhouse Gas Emissions

EU reduction in greenhouse gas emissions

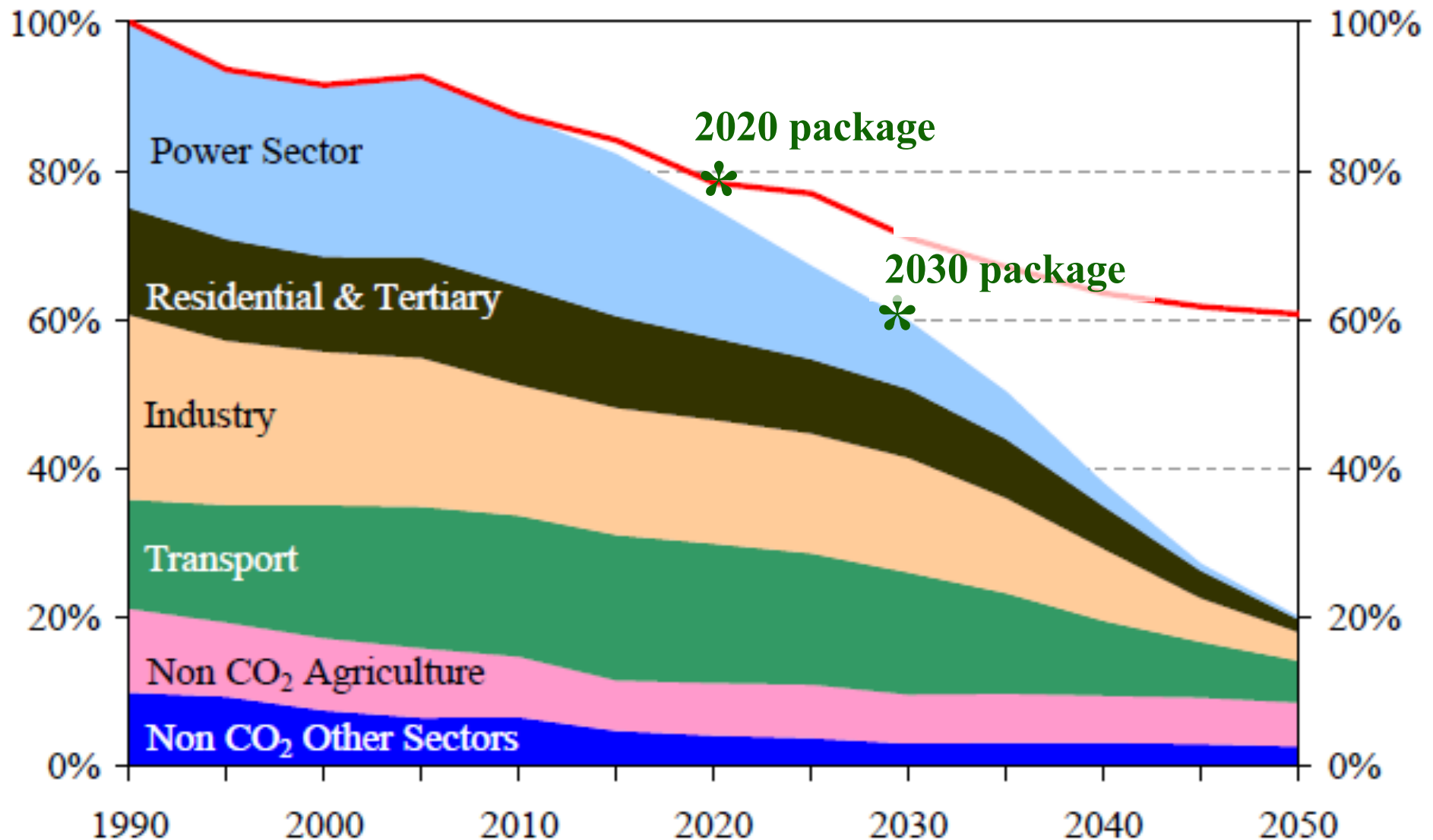

Our 3D energy future

Decarbonisation:

oil/coal-to-gas switch, renewable gas,
wind and sun, carbon capture and usage

Decentralisation:

Solar panels, micro-CHPs/fuel cells,
storage via power-to-gas and batteries

Digitalisation:

ICT for smart households and
smart gas/electricity grids

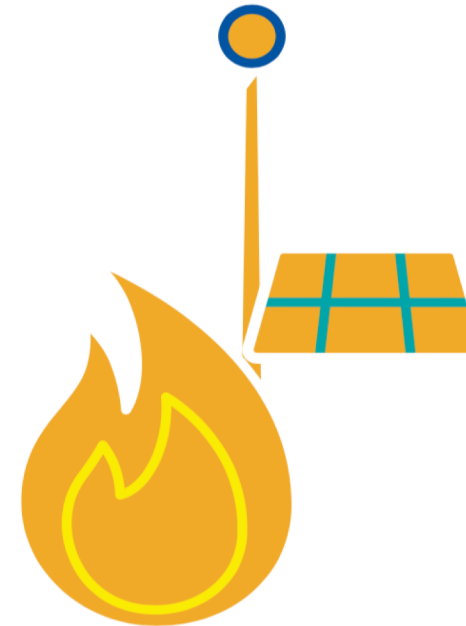

- **Extrapolating developments of the past does not forecast the future**
- **Gas, wind and sun – providing Europe with clean heat, electricity and transport**

Current energy system

EU energy system today*

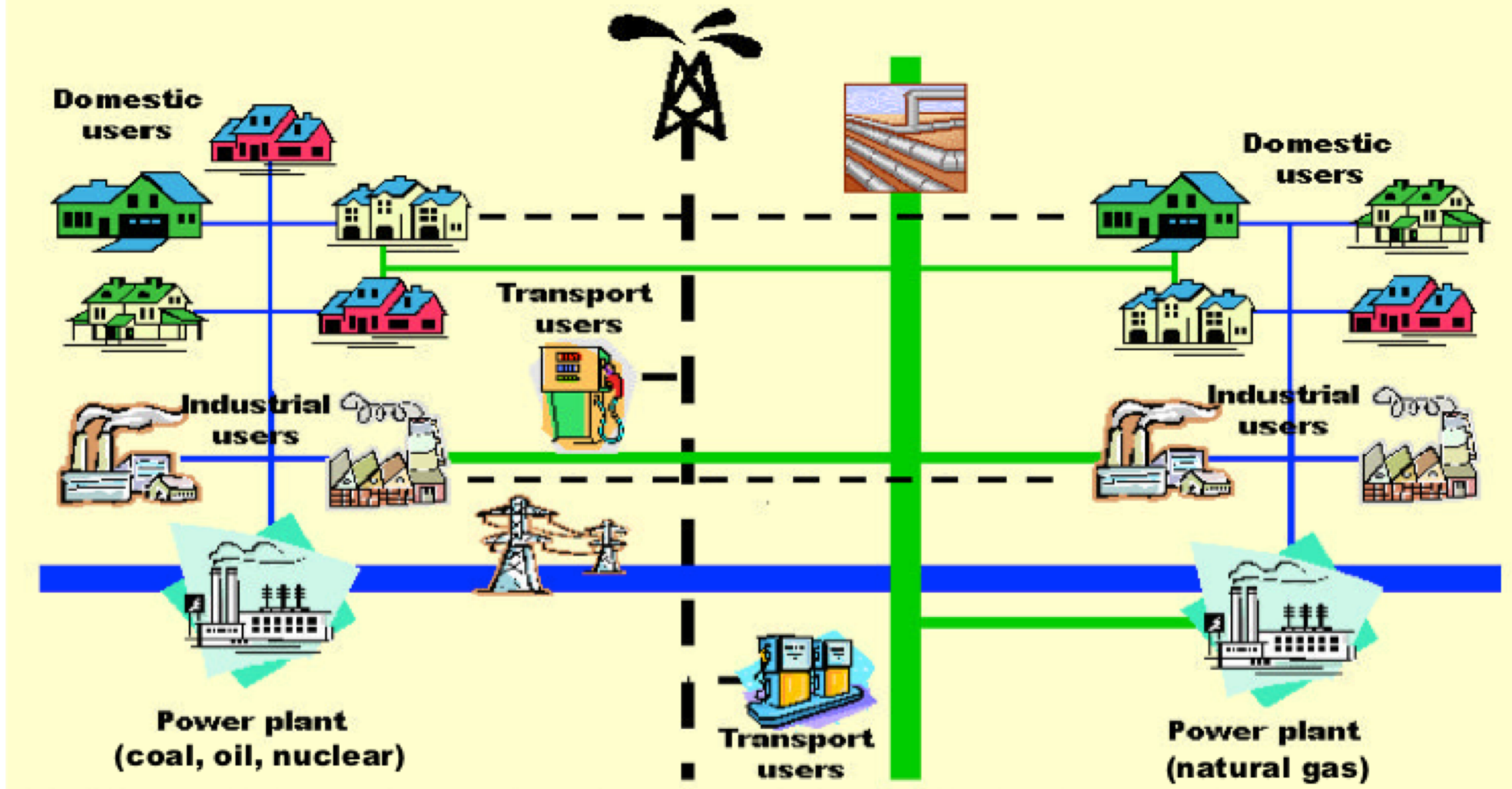

* Poulikkas A., 2009, *Introduction to Power Generation Technologies*, ISBN: 978-1-60876-472-3

Future energy systems (optimistic scenario)

EU energy system in 2020-30*

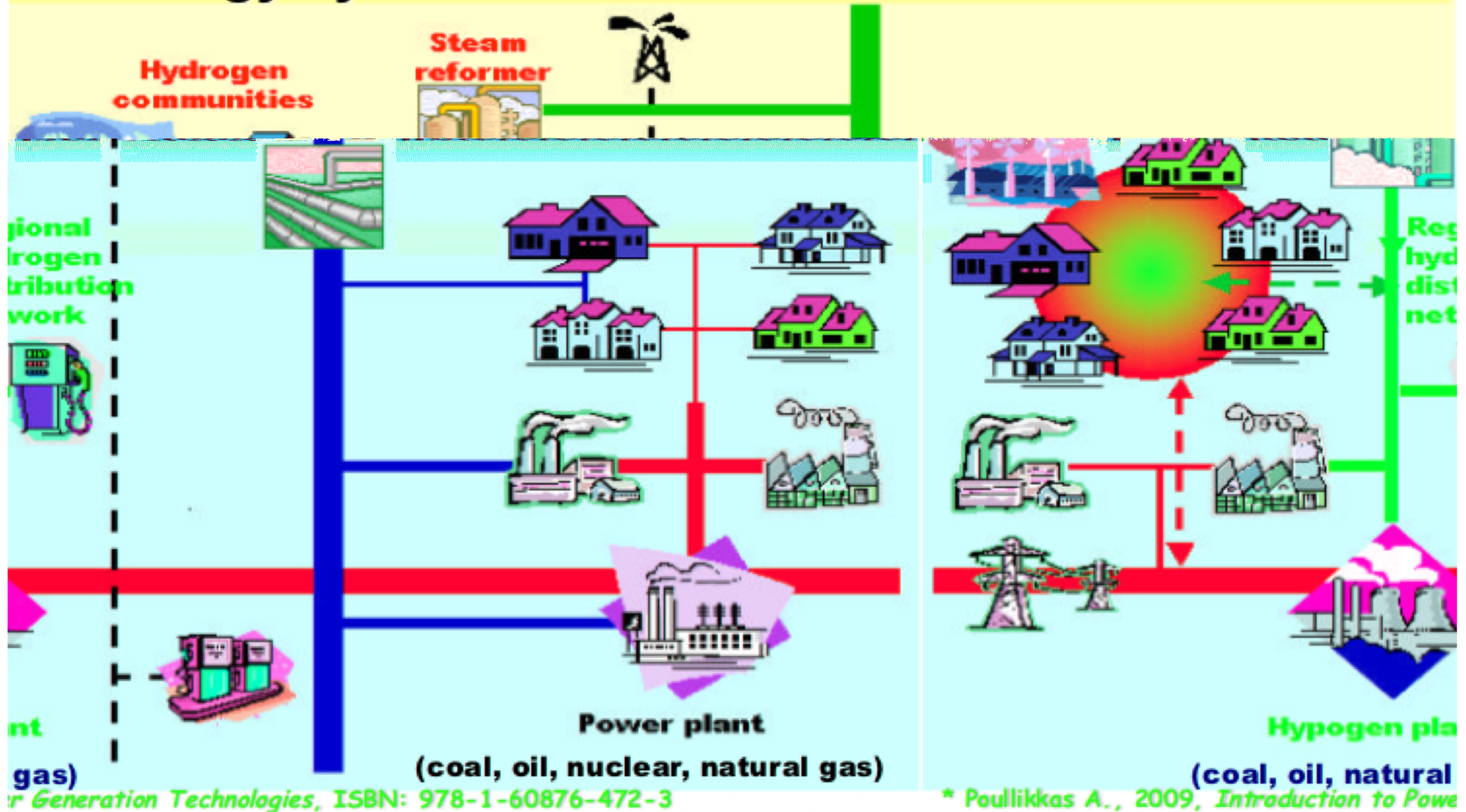

Future energy systems (optimistic scenario)

EU energy system in 2040-50*

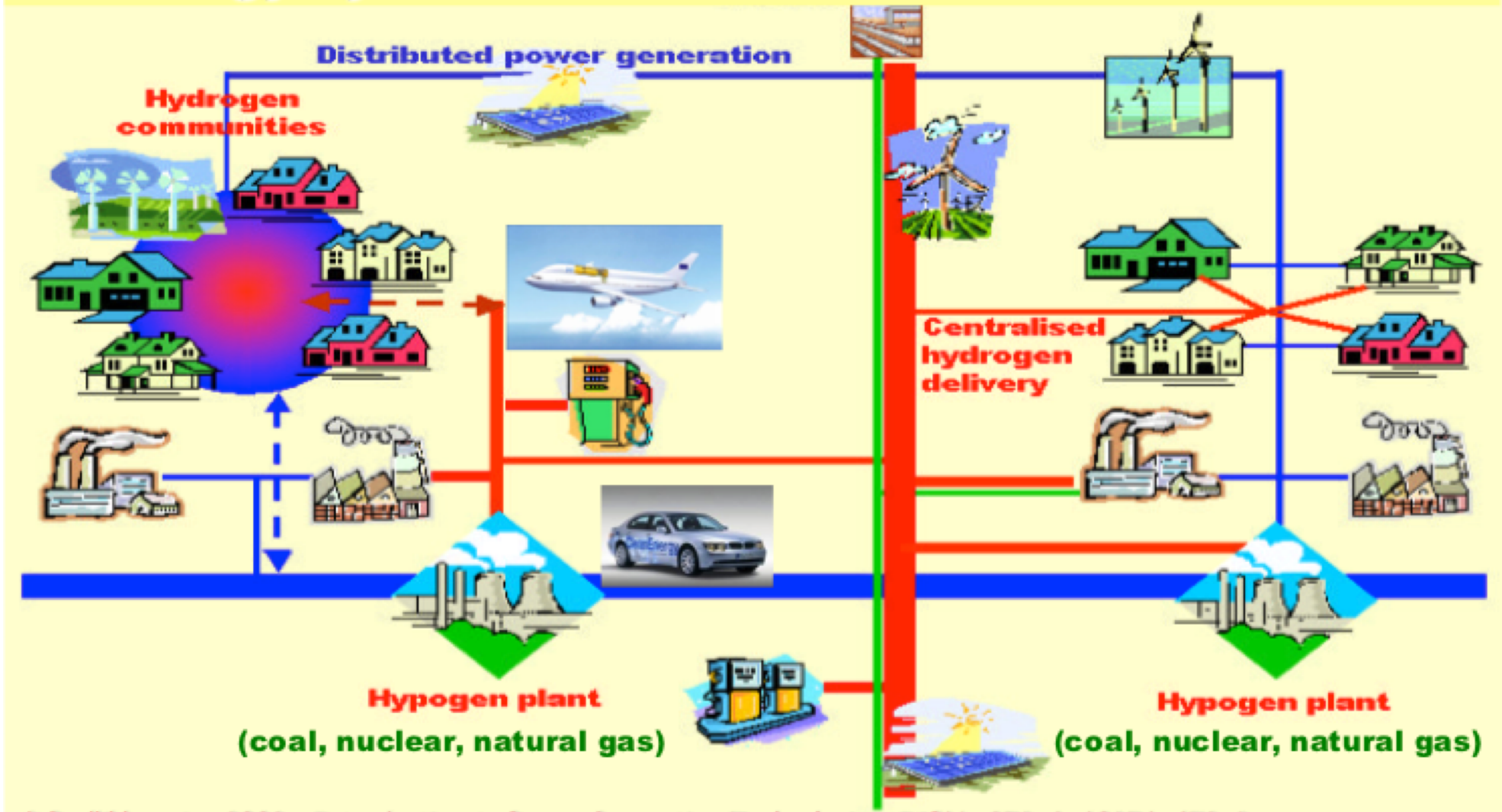

* Poullikkas A., 2009, *Introduction to Power Generation Technologies*, ISBN: 978-1-60876-472-3

Future power systems

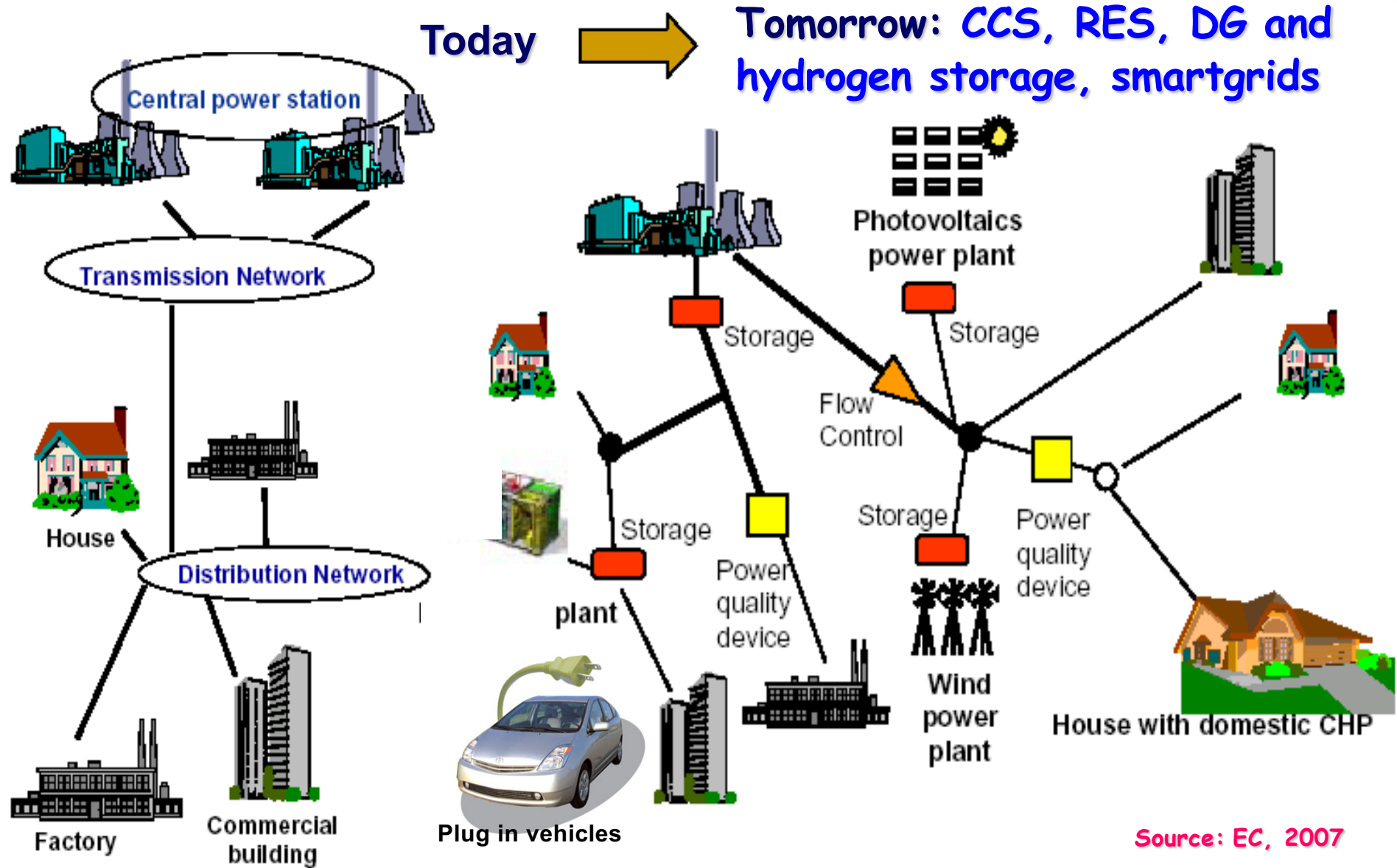

Source: EC, 2007

End goal – the smart future

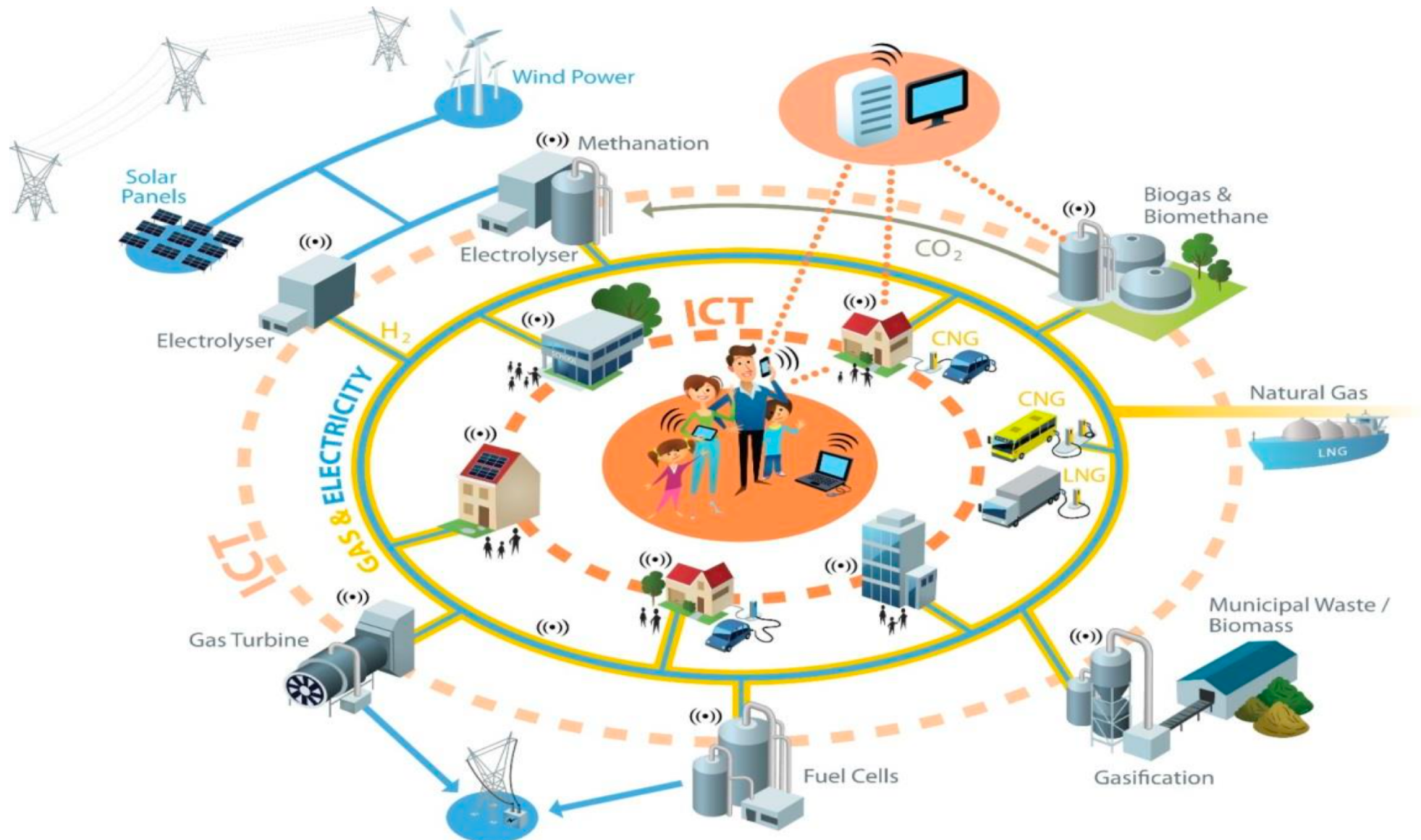

The Super Smart Grid after 2050* (may allow for 100% RES)

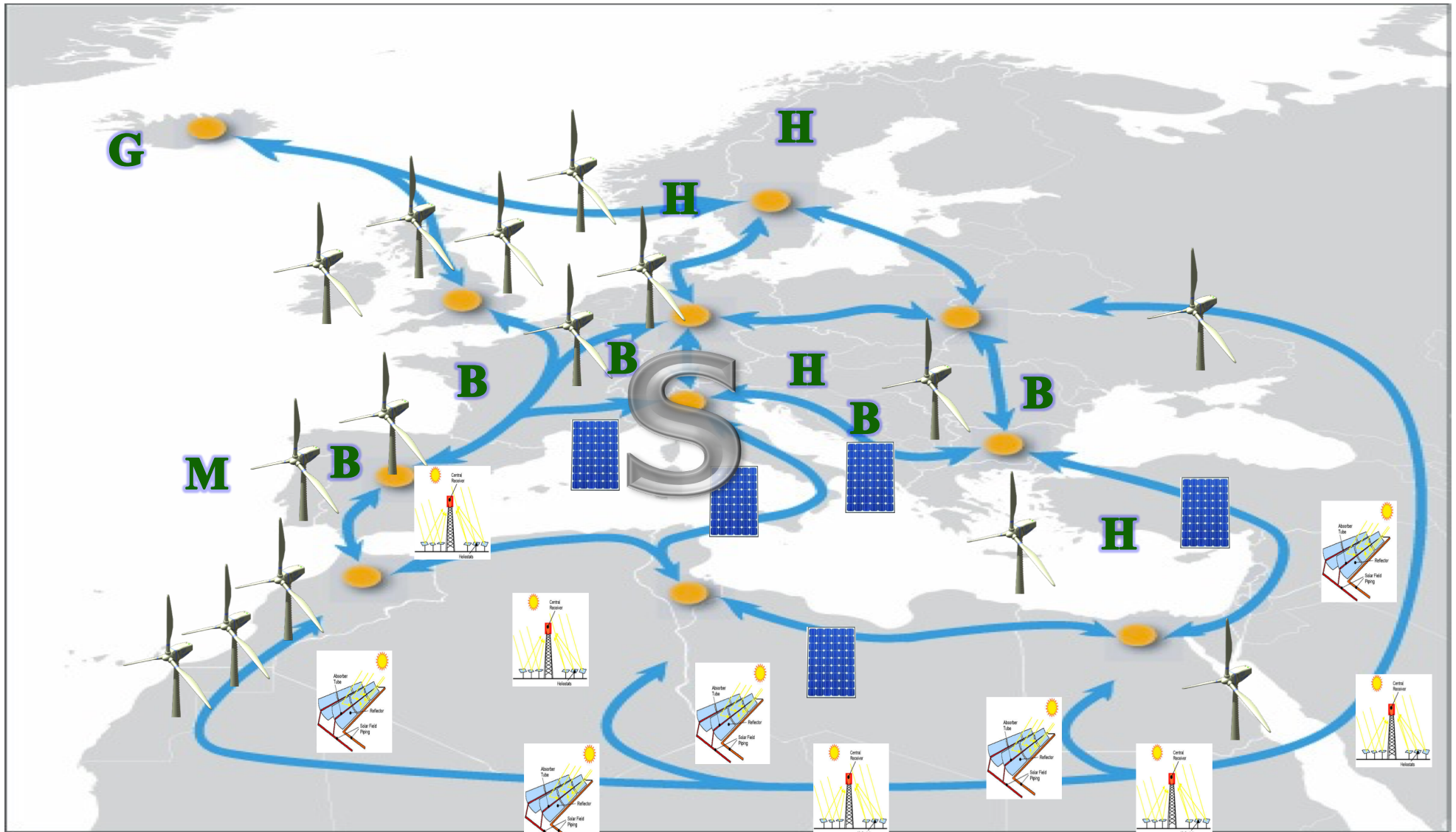

* Poulikkas A., 2013, *Sustainable Energy Development for Cyprus*, ISBN: 978-9963-7355-3-2

Long term EU energy strategy (2050)

- A vision of carbon free EU
- Main ingredients of future sustainable energy systems:
 - Large scale integration of renewable energy sources
 - Distributed generation
 - Carbon capture and storage
 - Smartgrids
 - Electric vehicles
 - Storage devices
 - Hydrogen

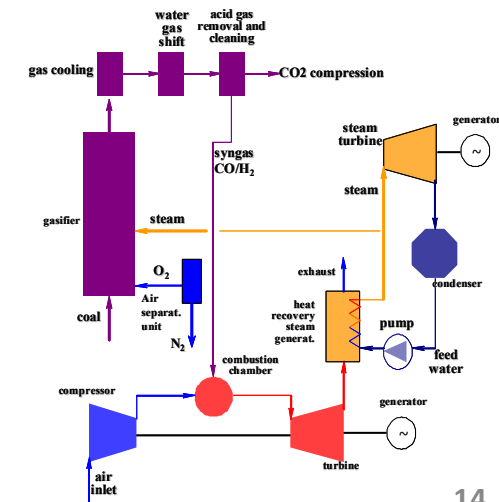

Need to develop advanced simulation tools, new sustainable technologies and infrastructure !!

Challenges in electricity markets

RES integration

EU electricity market target model

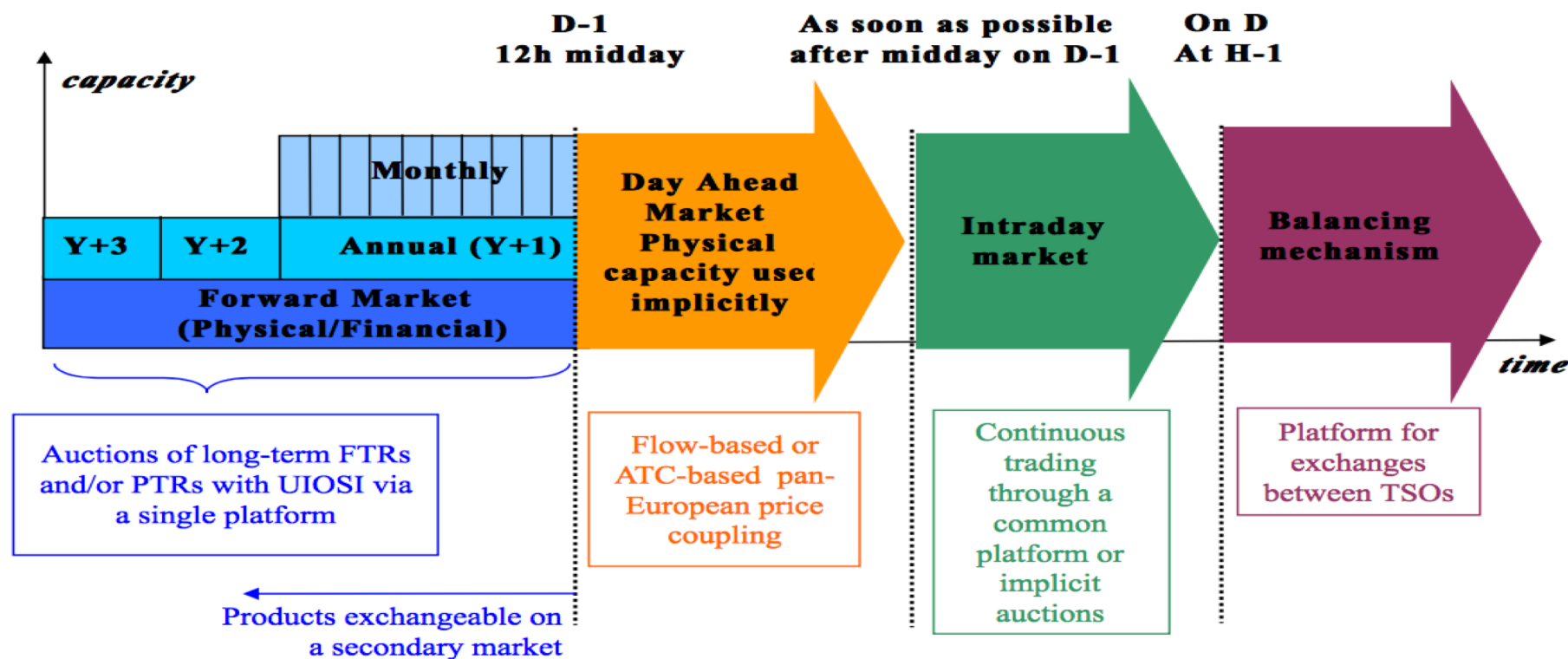

Integration of RES: LCOE vs Reliability

Power system reliability*

- **adequacy**, PS ability to satisfy customers needs both in power and electrical energy
- **security**, PS ability to remain in operation after sudden disturbances

* Poullikkas A., 2016, *Fundamentals of Energy Regulation*, ISBN: 978-9963-7355-8-7

Power system reliability* (the 6 must)

- Generation capacity **must** be greater than load
- Transmission **must** not be overloaded
- Voltages **must** be within limits
- **Must** be able to withstand loss of generator
- **Must** be able to withstand loss of transmission line
- **Must** not lose stability during short-circuit

* Poullikkas A., 2016, *Fundamentals of Energy Regulation*, ISBN: 978-9963-7355-8-7

Intermittent energy source*

- Any source of energy that is not continuously available
- May be quite predictable
- Cannot be dispatched to meet the demand of a power system
- For dispatching need storage

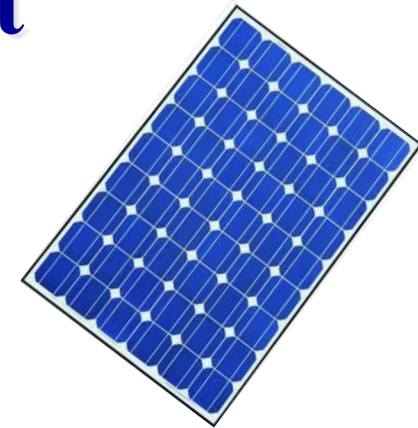

* Poullikkas A., 2013, *Renewable Energy: Economics, Emerging Technologies and Global Practices*, ISBN: 978-1-62618-231-8

Daily load curve (the 'camel curve')*

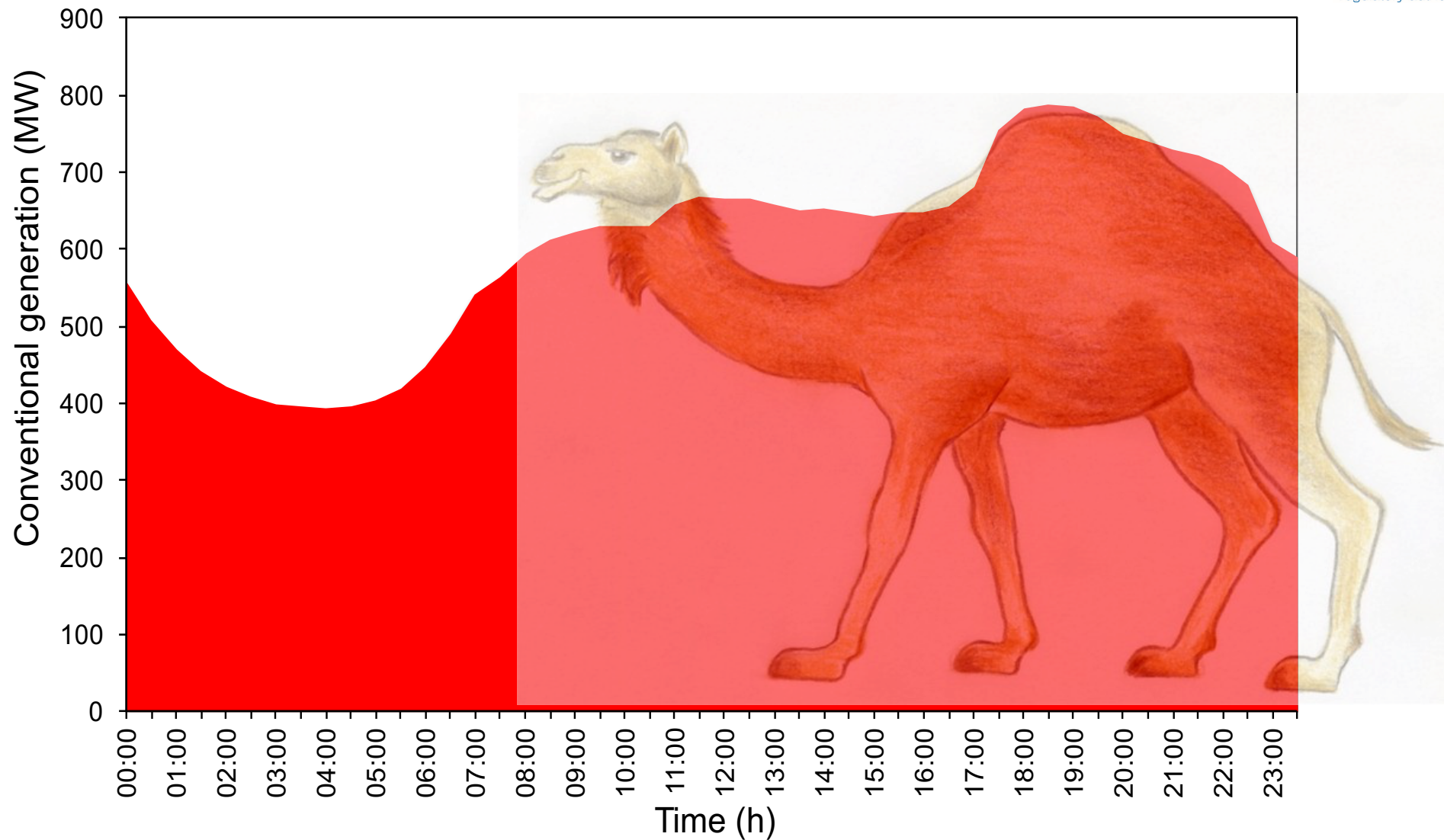

* Poullikkas A., 2016, "From the 'camel curve' to the 'duck curve' on electric systems with increasing solar power", *Accountancy*

Effect of PV generation on load curve (the 'duck curve')*

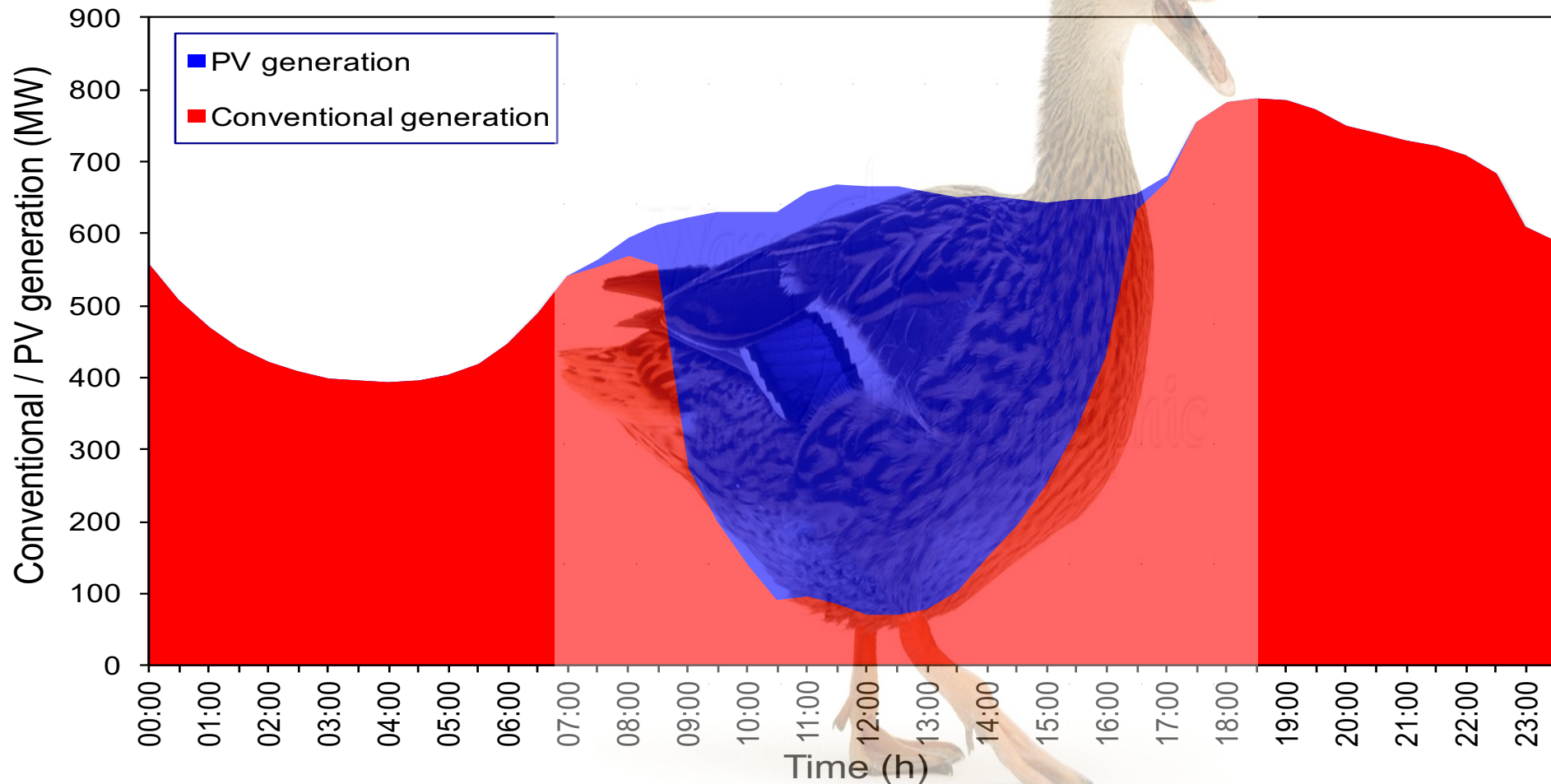

* Poullikkas A., 2016, "From the 'camel curve' to the 'duck curve' on electric systems with increasing solar power",
Accountancy

Gas is a pillar of renewable energy (power production in UK*)

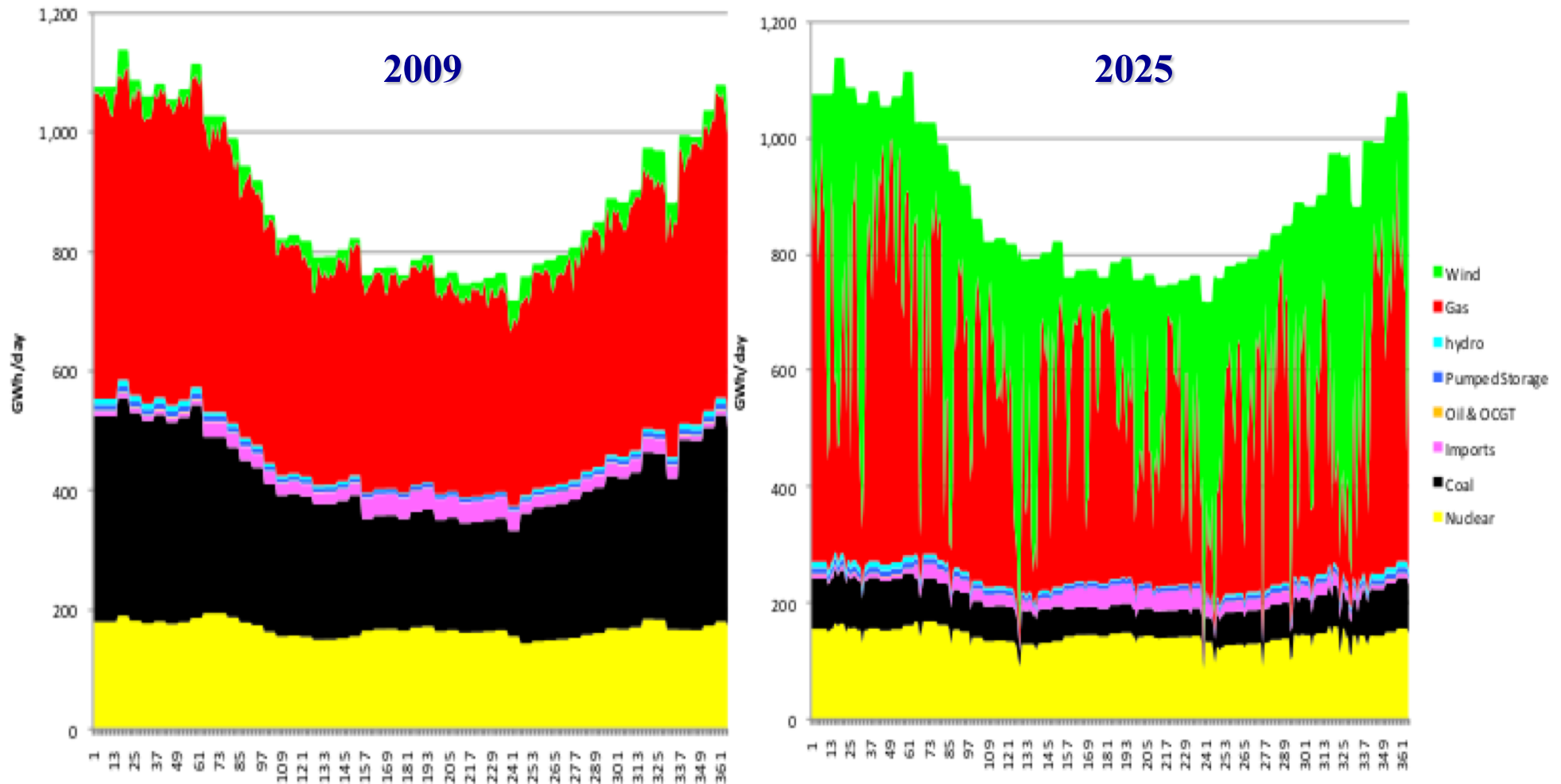

* H.V. Rogers, 2011, *The Impact of Import Dependence and Wind Generation on UK Gas Demand and Security of Supply to 2025*, The Oxford Institute For Energy Studies

Power-to-Gas (P2G)

- energy storage technology linking the electricity and gas infrastructure

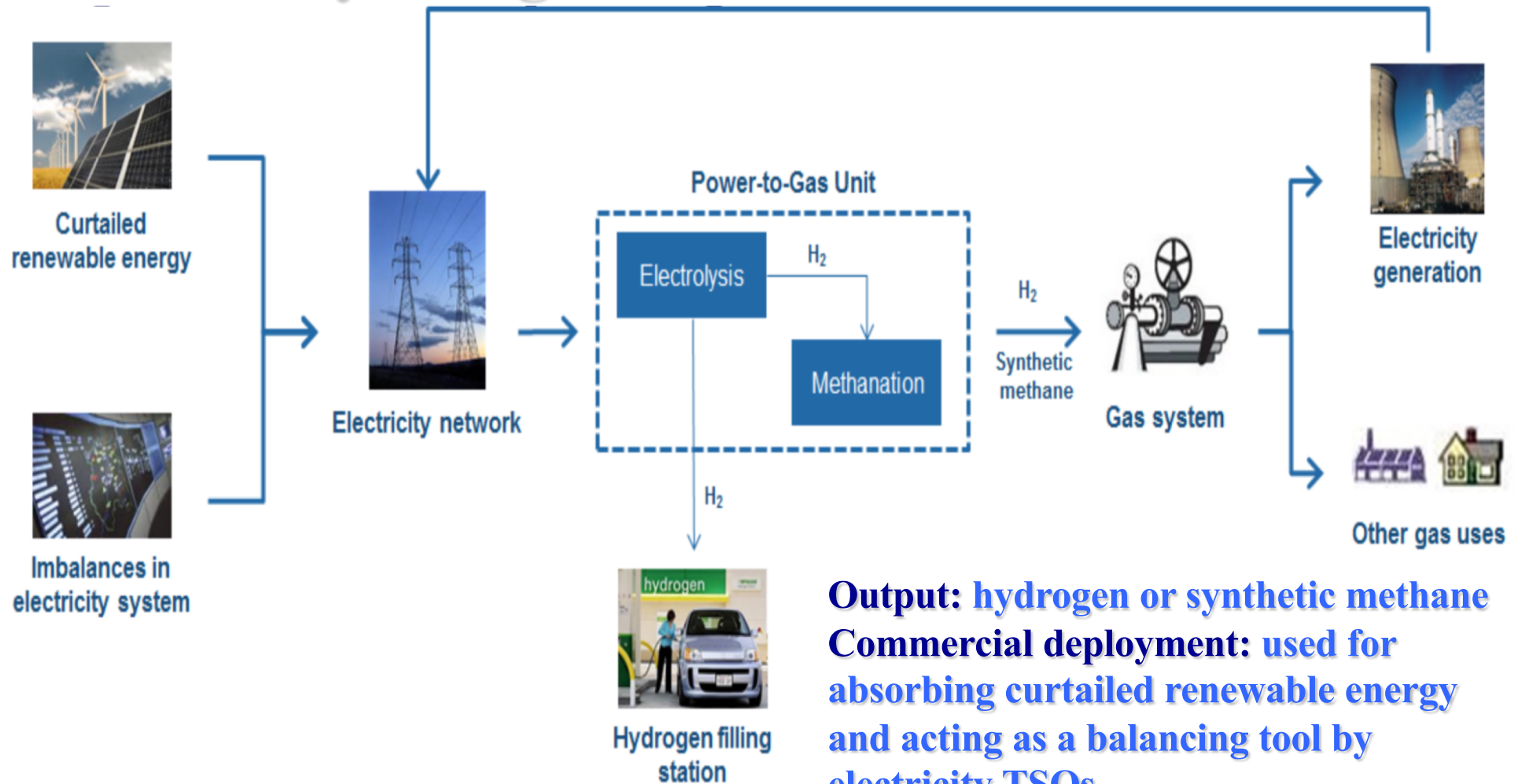

Storage is the missing link

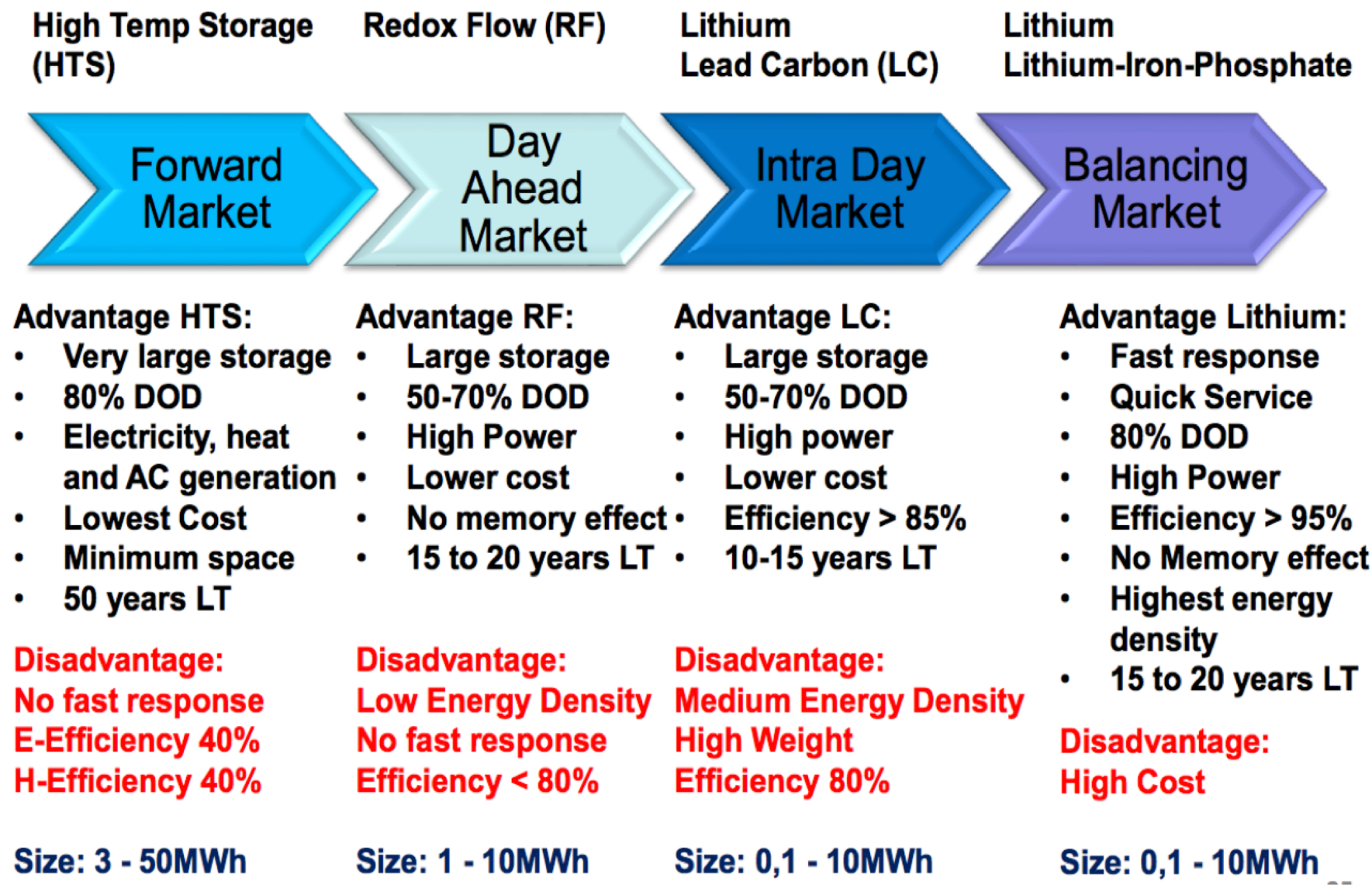

Modeling for optimum large scale integration of RES

Advanced simulation tools

The problem

The need

- **Large scale integration of RES**
 - **e.g., EU RES targets by 2020, 2030**

Main objective

- **Assessment of the increase (or benefit) in the cost of electricity of a given power generation system at different RES-E penetration levels**

Model capabilities

- **Use of unit commitment algorithms**
- **Energy mix and include storage**
- **Cost or benefit in the cost of electricity**
- **Price of FiT, FiP, etc**
- **Green tax (if necessary)**

Objective function*

- **Minimizing total cost**

$$\min C = \min \sum_{i=1}^n x_i (c_i)$$

- **satisfy constraints**

$$P_{D(t)} = \sum_i I_{(i,t)} P_{(i,t)}$$

$$P_{g,\min(i)} \leq P_{(i,t)} \leq P_{g,\max(i)}$$

$$R_{O(t)} \leq \sum_i r_{o(i,t)} I_{(i,t)} \quad r_{o(i,t)} = \begin{cases} q_i, & \text{if unit } i \text{ is OFF} \\ r_{s(i,t)}, & \text{if unit } i \text{ is ON} \end{cases}$$

$$R_{S(t)} \leq \sum_i r_{s(i,t)} I_{(i,t)} \quad r_{s(i,t)} = \min[10MSR_i, P_{g,\max(i)} - P_{(i,t)}]$$

$$\sum_i \sum_t C_{ei} [P_{(i,t)} I_{(i,t)}] + S_{e(i,t)} \leq E_{\max}$$

$$-P_{km}^{\max} \leq P_{km(t)} = f[\mathbf{B}_{(t)}, \varphi_{(t)}] \leq P_{km}^{\max}$$

- **Load demand**
- **Unit capacity**
- **Available capacity**
- **Reserve margin**
- **Spinning reserve**
- **Fuel constraints**
- **Environmental constraints**
- **Power transmission constraints, etc**

* Poullikkas A., 2009, "A decouple optimization method for power technology selection in competitive markets", *Energy Sources*

Typical shape of objective function*

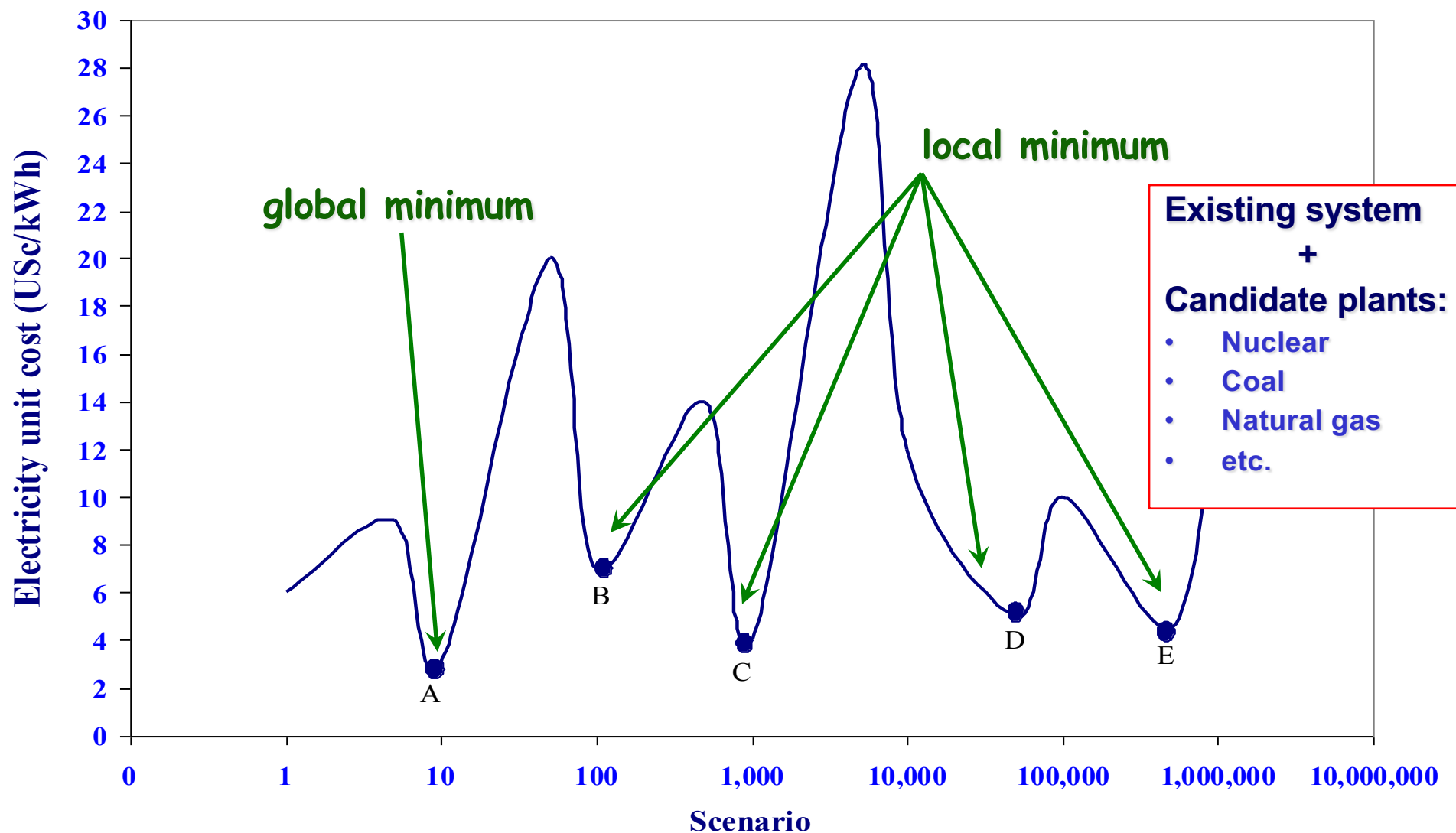

* Poullikkas A., 2009, "A decouple optimization method for power technology selection in competitive markets", *Energy Sources*

Optimization model*,**

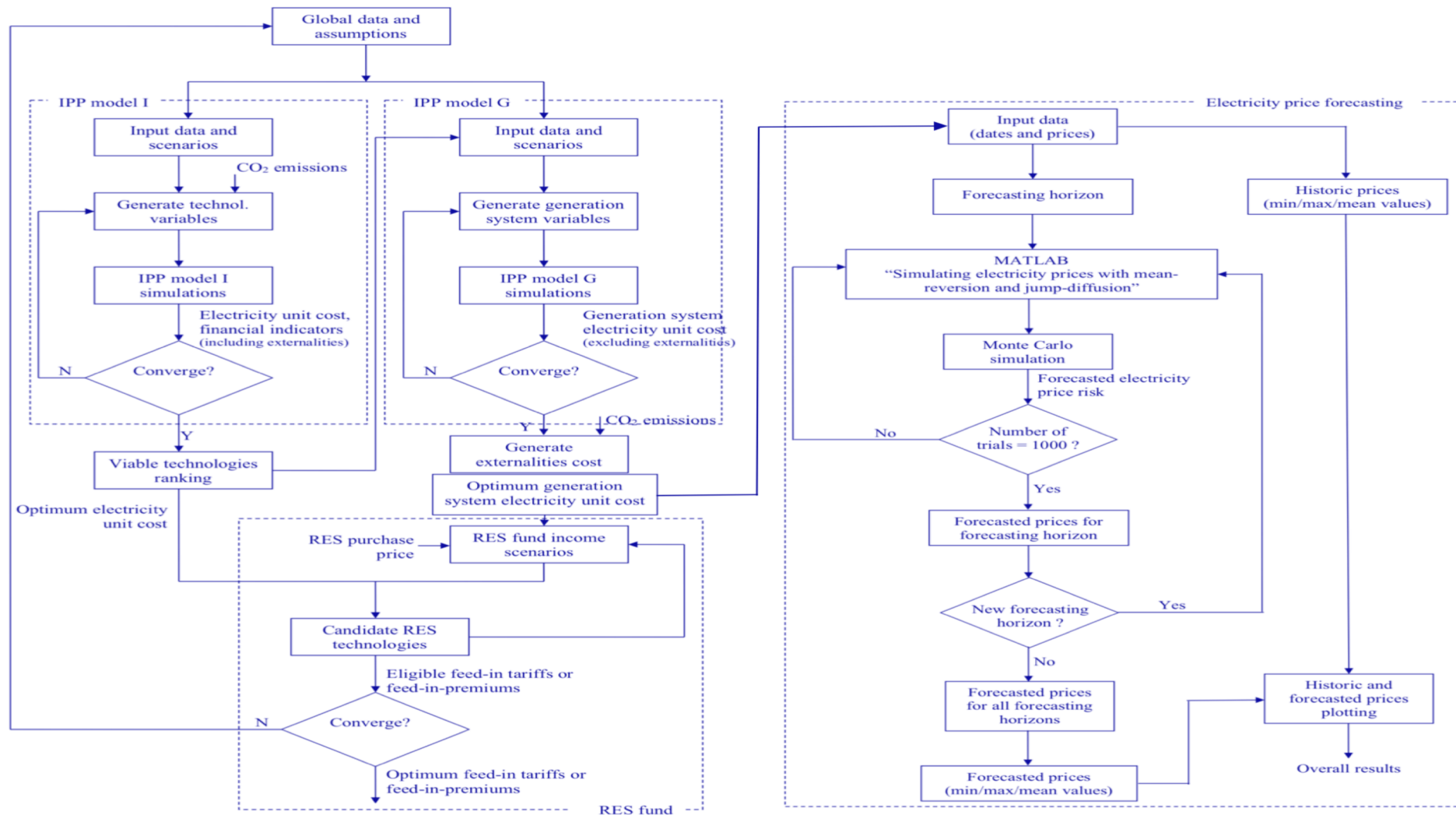

* Poullikkas A., Kourtis G., Hadjipaschalis I., 2011, "A hybrid model for the optimum integration of renewable technologies in power generation systems", *Energy Policy*

** Poullikkas A., 2018, "An adaptive longterm electricity price risk modelling using Monte Carlo simulation", *Journal of Power Technologies*

Decoupled objective function*

$$\min\left(\frac{\partial c}{\partial k}\right) = \min \left\{ \begin{array}{l} \sum_{j=0}^N \left[\frac{\frac{\partial C_{Cj}}{\partial k} + \frac{\partial C_{Fj}}{\partial k} + \frac{\partial C_{OMFj}}{\partial k} + \frac{\partial C_{OMVj}}{\partial k}}{(1+i)^j} \right] \\ \sum_{j=0}^N \left[\frac{\partial P_j}{\partial k} \right] \end{array} \right\}$$

Capital (\$) Fuel (\$) Fixed O&M (\$) Variable O&M (\$)

Electricity unit cost (\$c/kWh)

Energy (kWh)

* Poullikkas A., IPP algorithm version 2.1, User manual, © 2000-2006

Total electricity generation for 50MW (20y)*

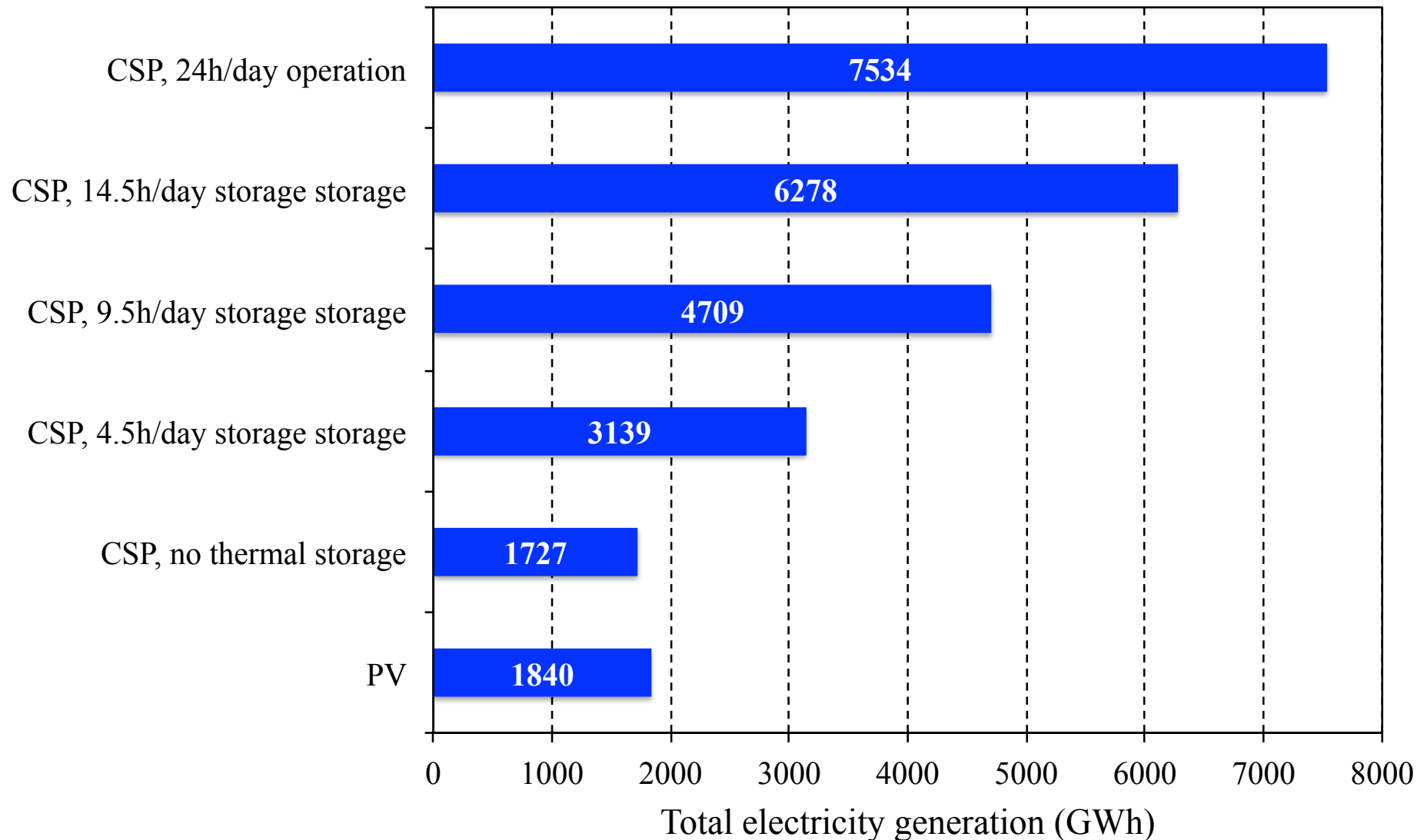

* Poullikkas A., Gadalla M., 2013, "Assessment of solar electricity production in United Arab Emirates", *International Journal of Sustainable Energy*

6th International Conference on Renewable Energy Sources and Energy Efficiency - New Challenges (RESEE2018)
Nicosia, Cyprus, Nov 1-2, 2018

Annual CO₂ avoided emissions*

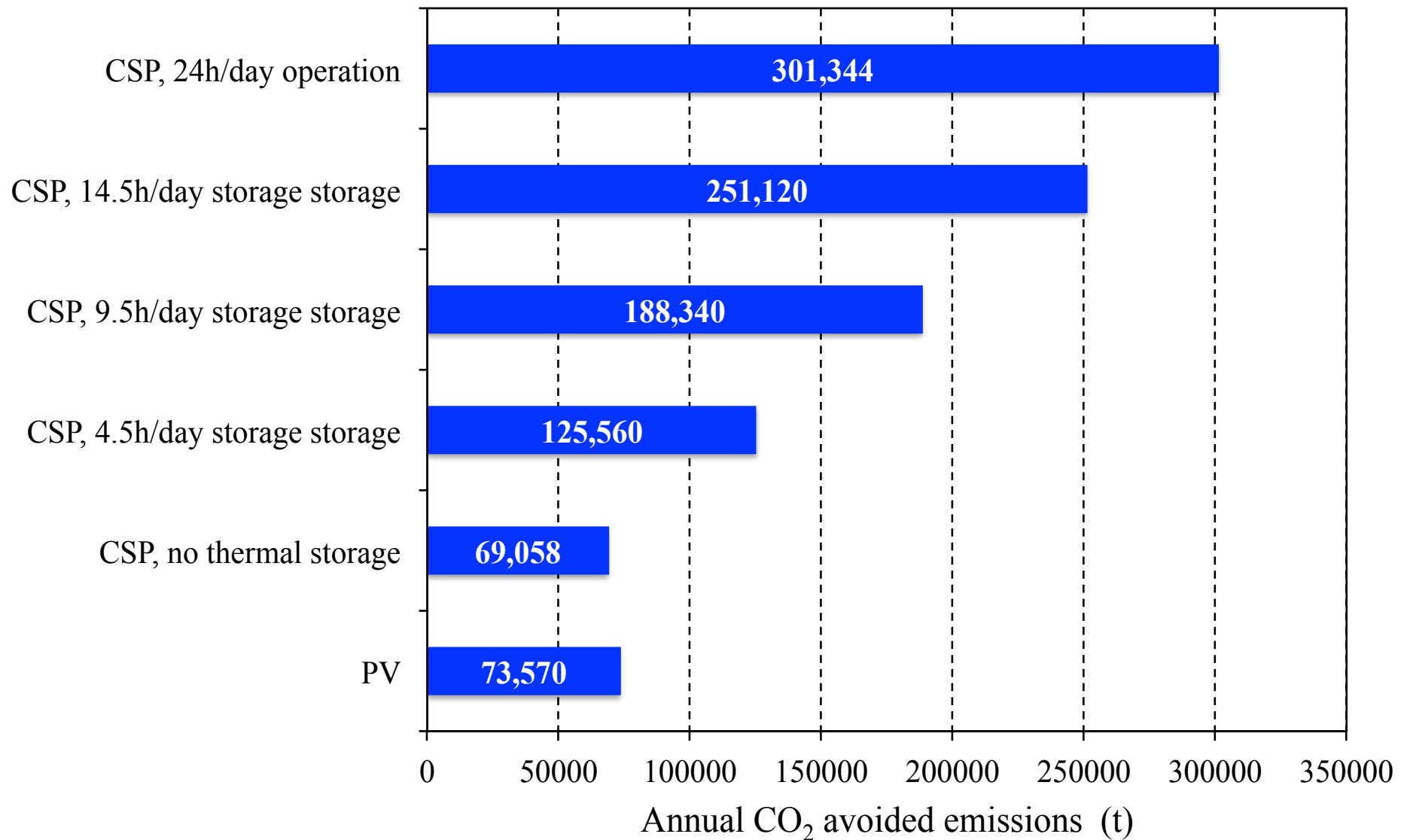

* Poullikkas A., Gadalla M., 2013, "Assessment of solar electricity production in United Arab Emirates", *International Journal of Sustainable Energy*

6th International Conference on Renewable Energy Sources and Energy Efficiency - New Challenges (RESEE2018)
Nicosia, Cyprus, Nov 1-2, 2018

LCOE parametric curves*

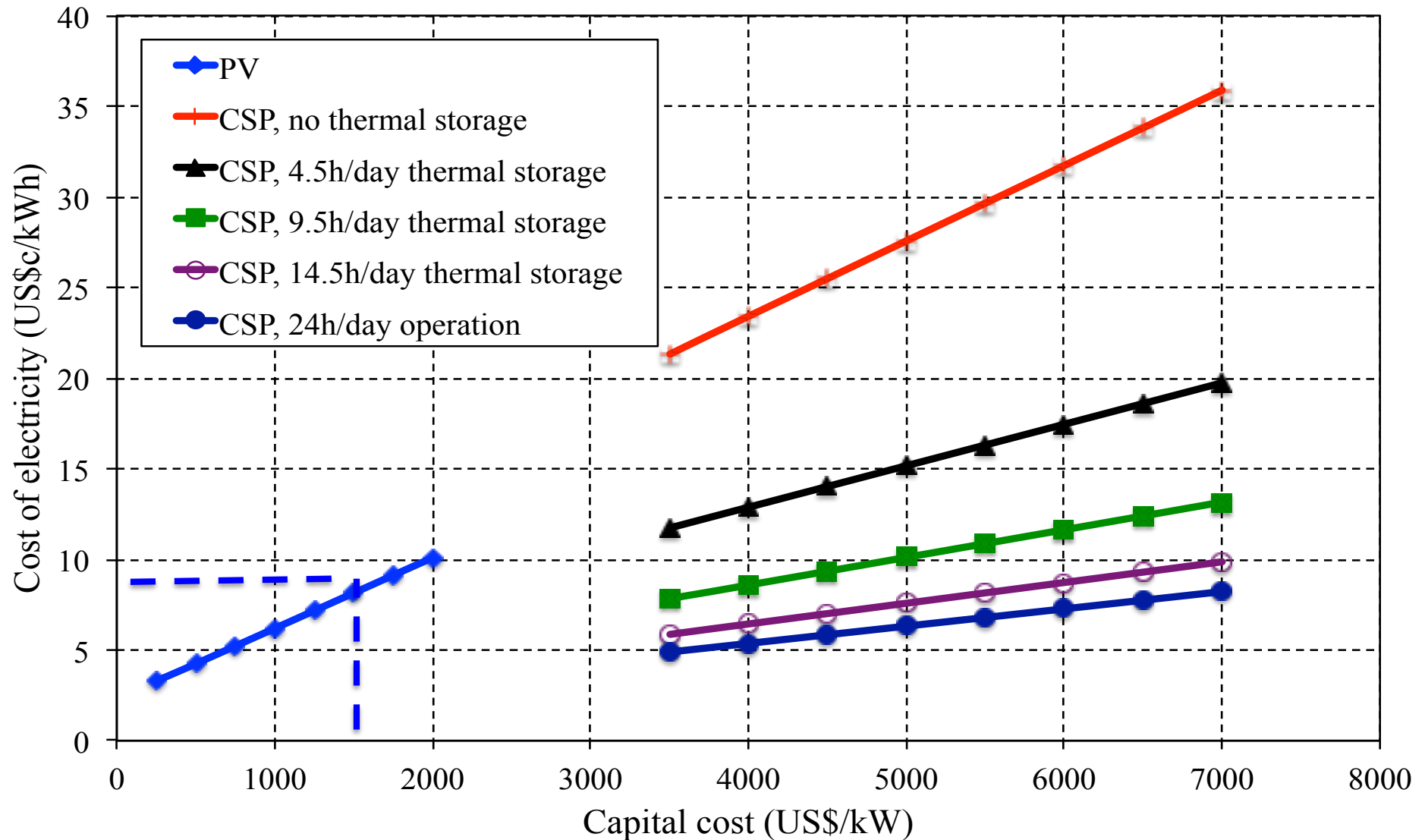

* Poullikkas A., Zueter A.F., Dirar M.H., 2014, "Prospective scenarios for the adoption of sustainable power generation technologies in United Arab Emirates", *International Journal of Sustainable Energy*

Typical net power output profile during summer*

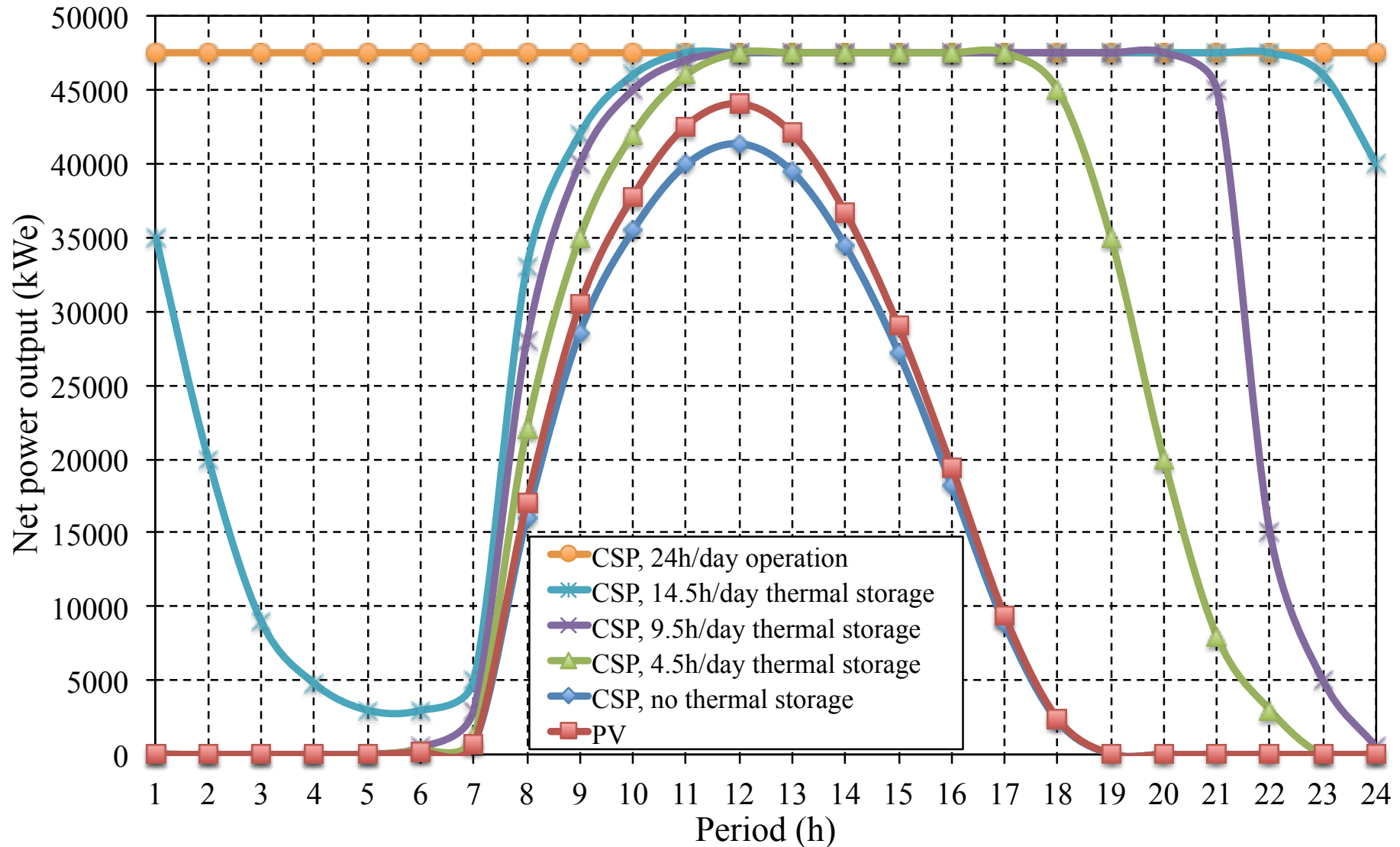

* Poullikkas A., Gadalla M., 2013, "Assessment of solar electricity production in United Arab Emirates", *International Journal of Sustainable Energy*

Typical net power output profile during winter*

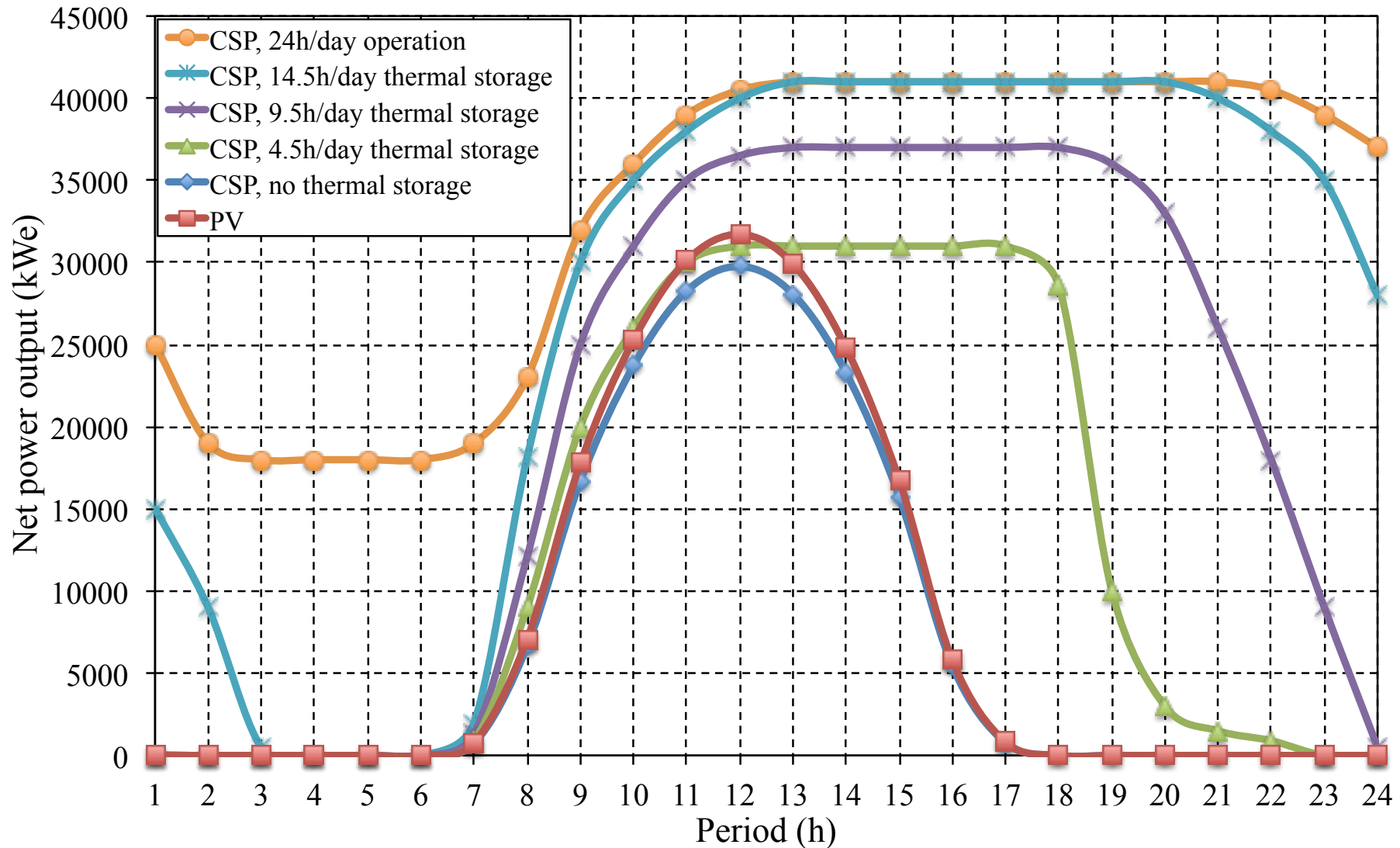

* Poullikkas A., Gadalla M., 2013, "Assessment of solar electricity production in United Arab Emirates", *International Journal of Sustainable Energy*

Cost of reserves with RES production*

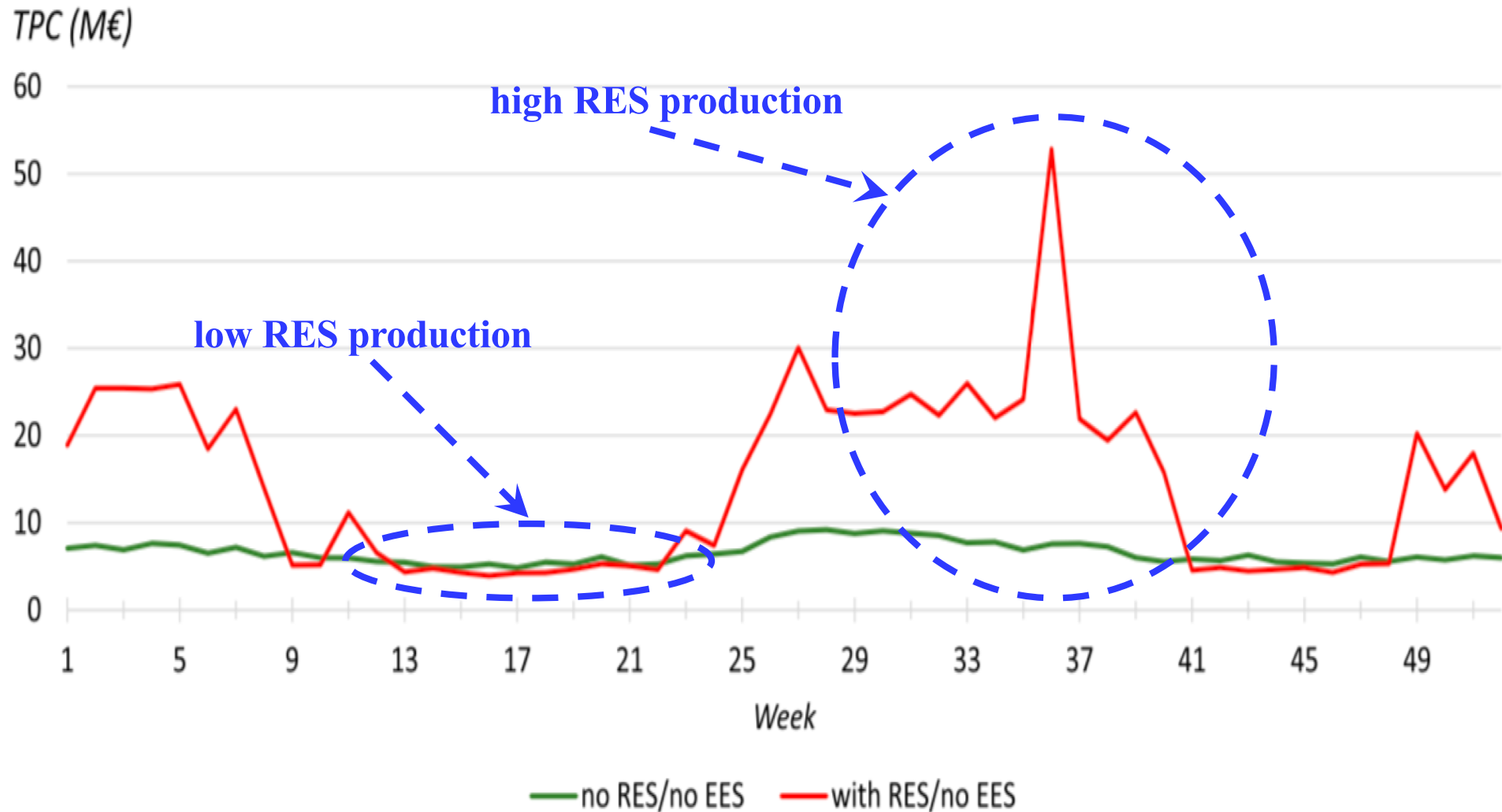

* Nicolaidis P., Chatzis S., Poullikkas A., 2018, “Renewable energy integration through optimal unit commitment and electricity storage in weak power networks”, *International Journal of Sustainable Energy*

Integration of storage*

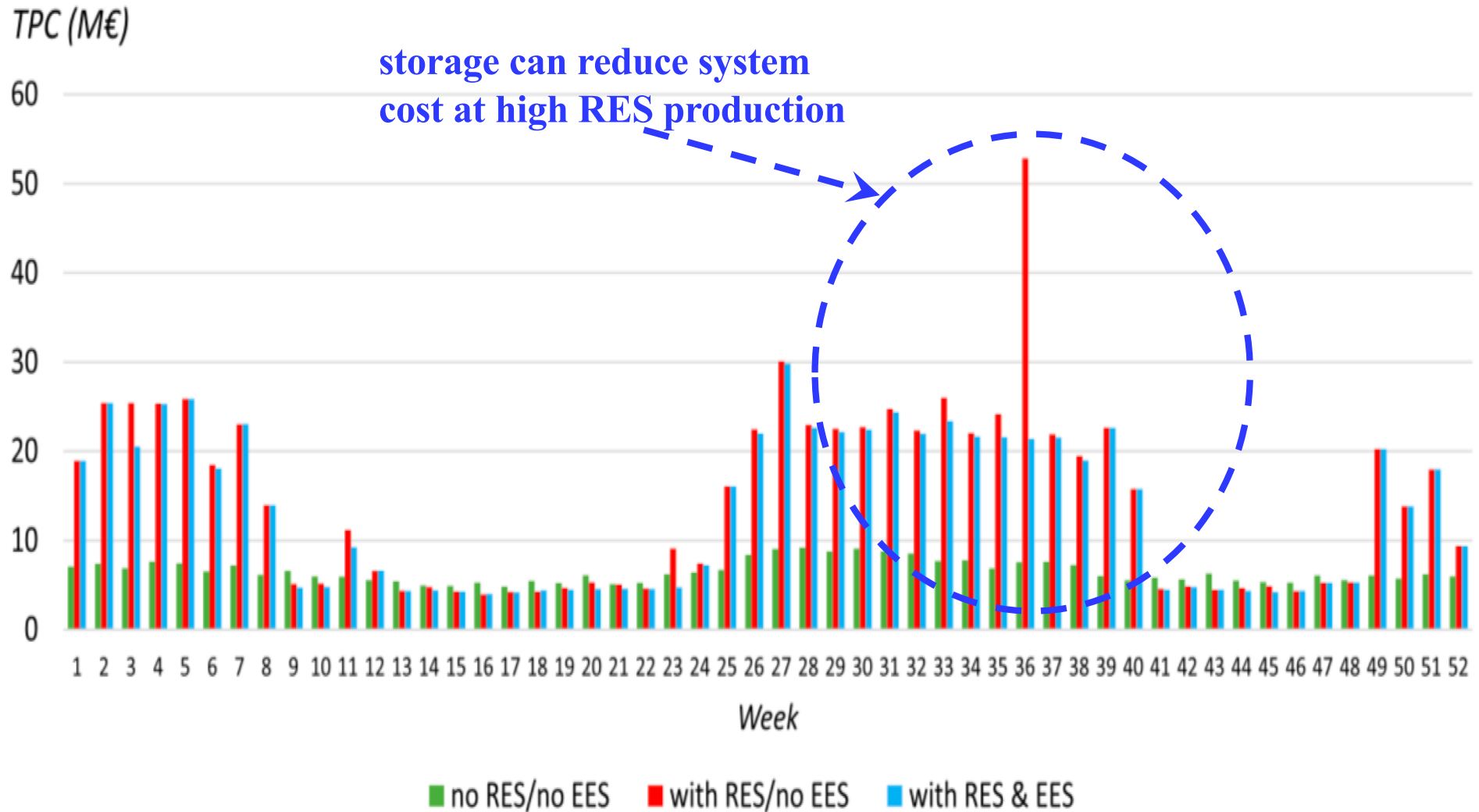

* Nicolaidis P., Chatzis S., Poullikkas A., 2018, "Renewable energy integration through optimal unit commitment and electricity storage in weak power networks", *International Journal of Sustainable Energy*