



Natural gas strategies for sustainable energy systems

Dr. Andreas Poulikkas

Ph.D, D.Tech, FIET

Chairman, Cyprus Energy Regulatory Authority

apoulikkas@cera.org.cy

Contents

- **Future sustainable energy systems**
- **Cyprus current electricity and NG systems – statistics**
- **The role of natural gas – towards sustainable energy systems**

Future sustainable energy systems

Towards sustainability

Future energy systems

- **Climate change**

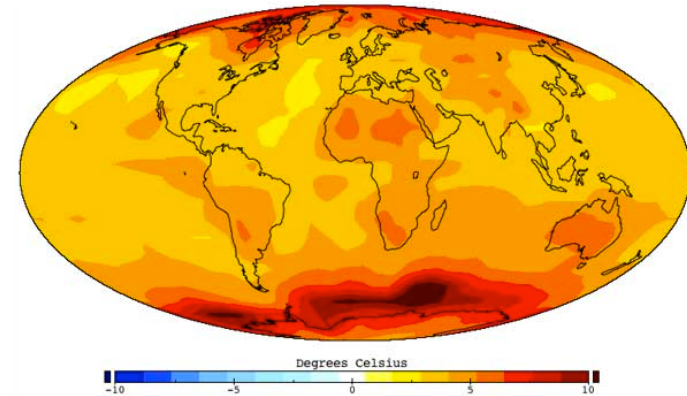

- **Third energy revolution**

- **Future energy economics**

EU energy objectives

- **greenhouse gas reduction**
- **sustainable production and consumption**
- **competition in electricity and natural gas markets**
- **security of supply**

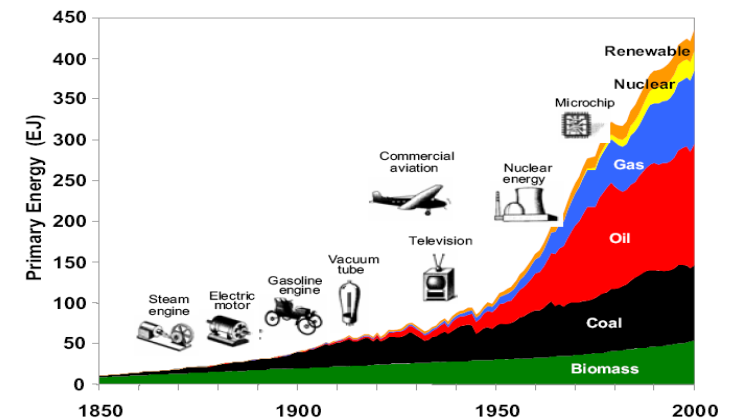

Current energy system

EU energy system today*

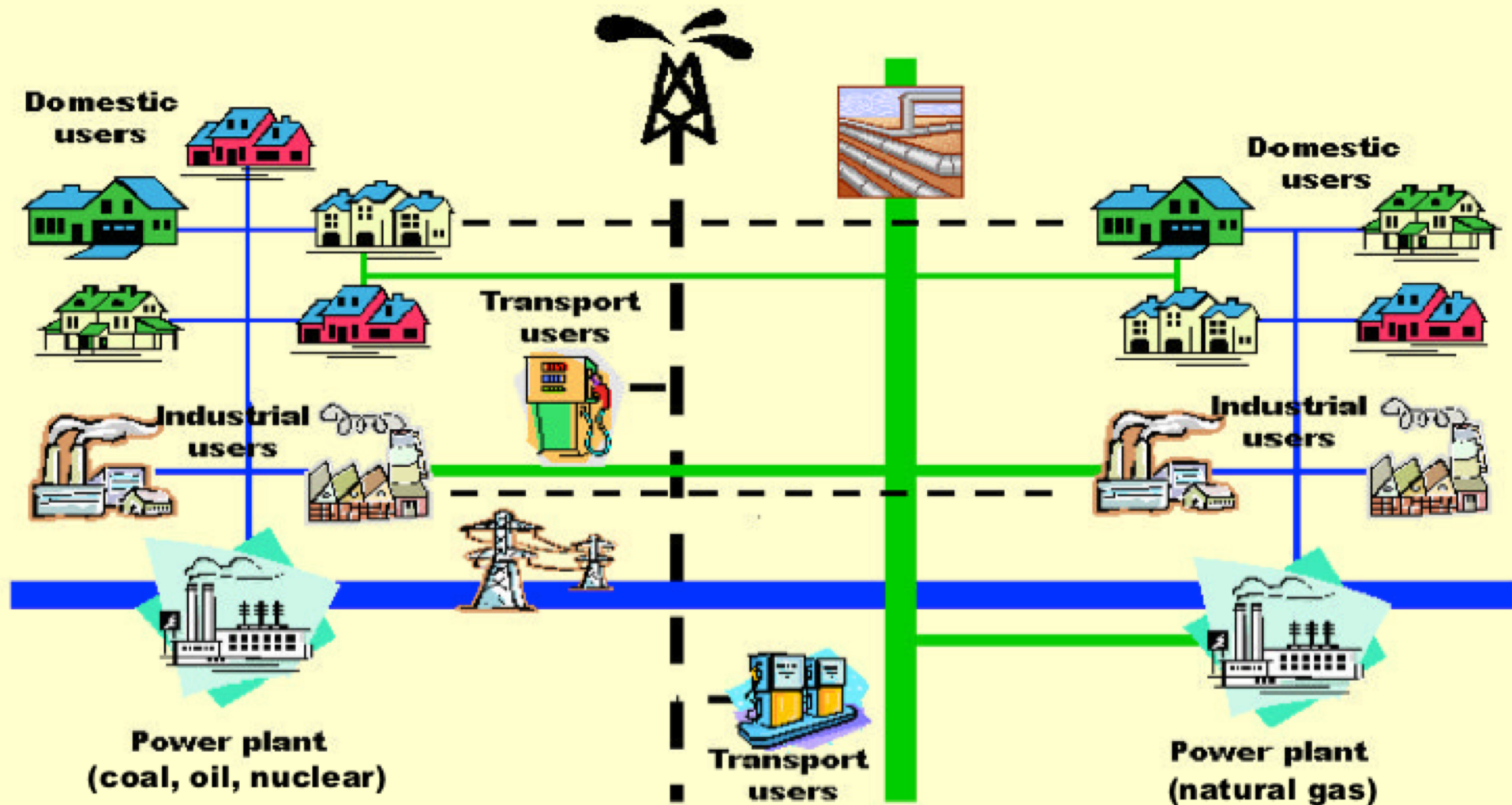

* Poulikkas A., 2009, *Introduction to Power Generation Technologies*, ISBN: 978-1-60876-472-3

Future energy systems (optimistic scenario)

EU energy system in 2020-30*

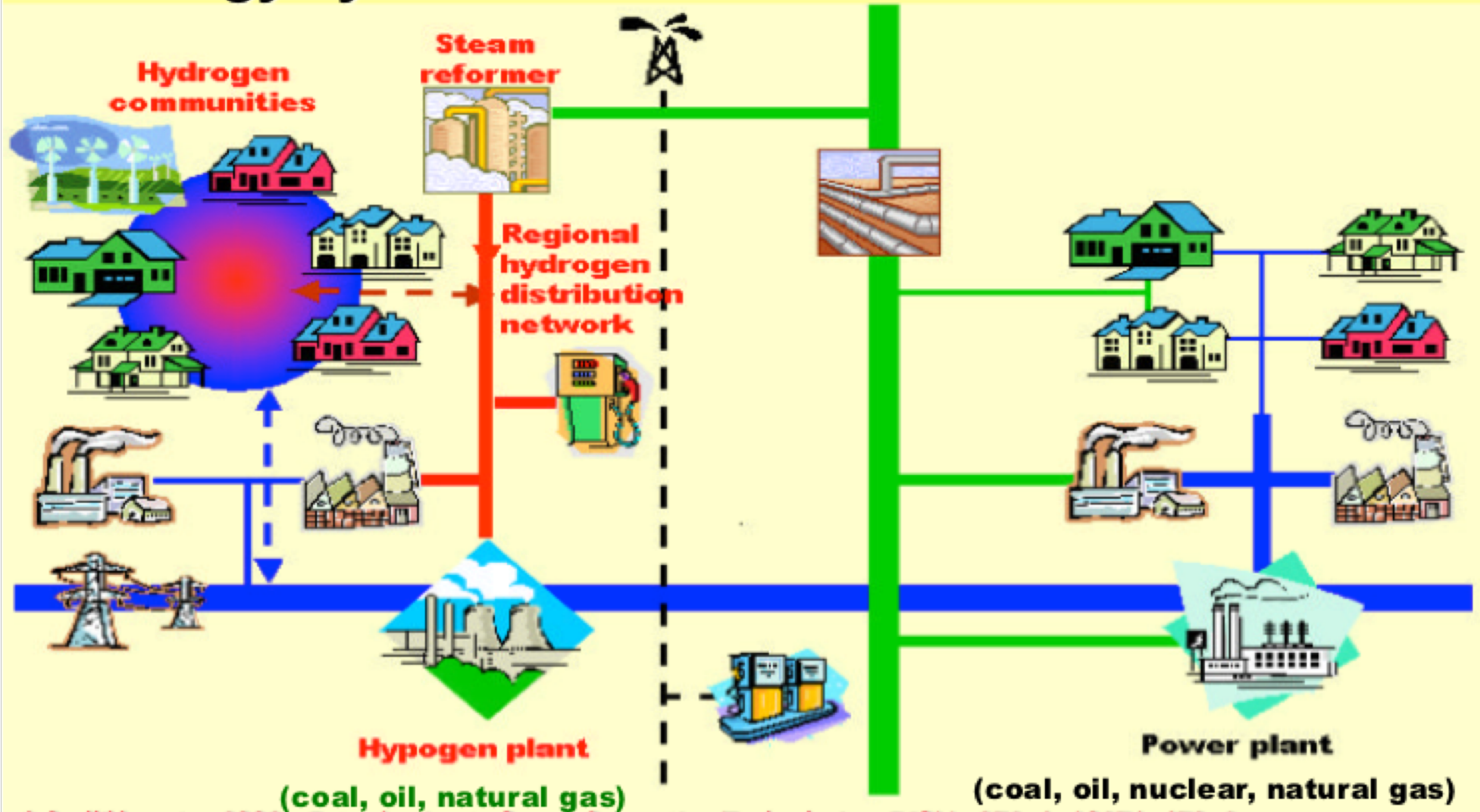

* Poullikkas A., 2009, *Introduction to Power Generation Technologies*, ISBN: 978-1-60876-472-3

Future energy systems (optimistic scenario)

EU energy system in 2040-50*

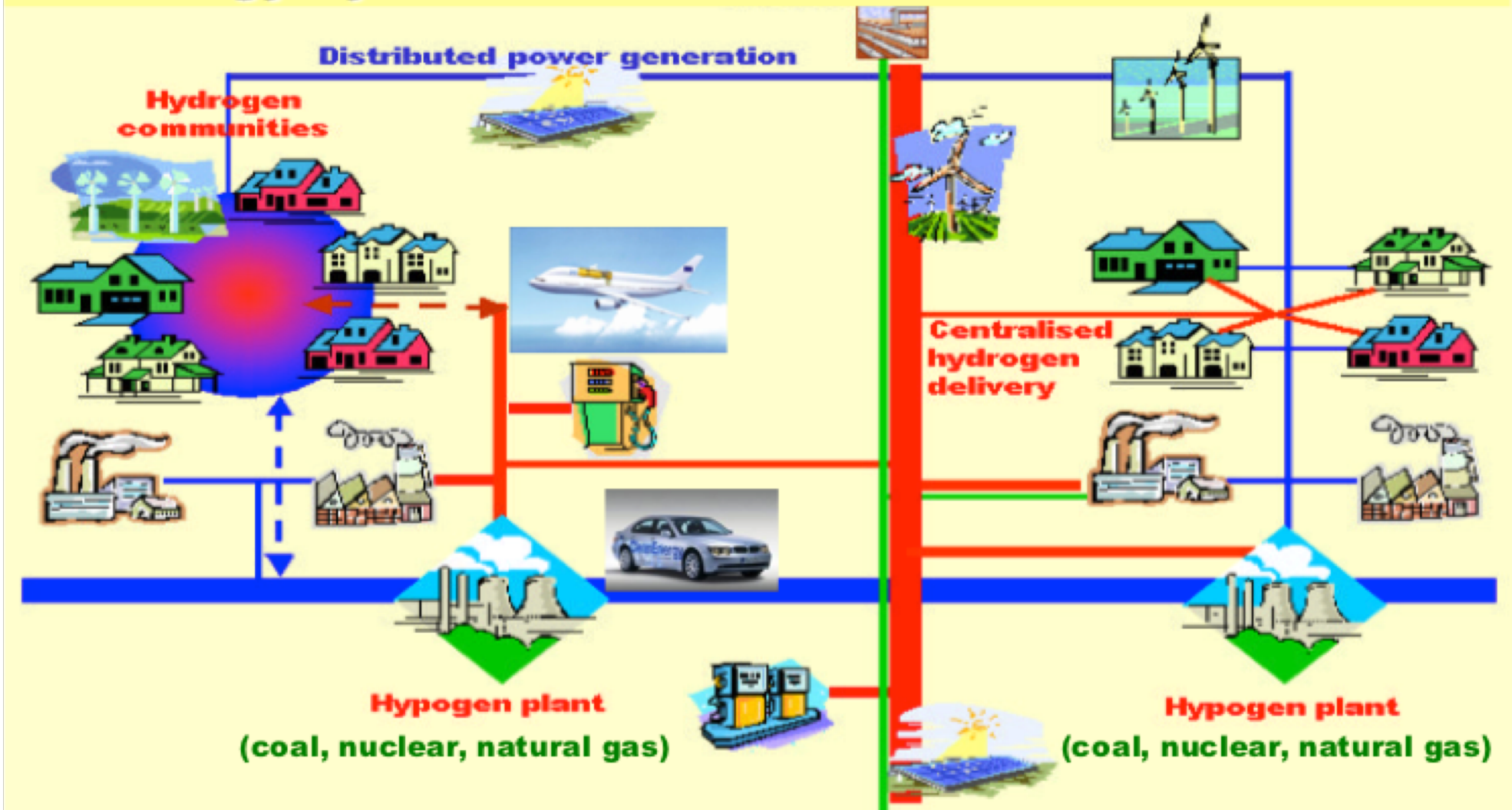

* Poullikkas A., 2009, *Introduction to Power Generation Technologies*, ISBN: 978-1-60876-472-3

Future power systems

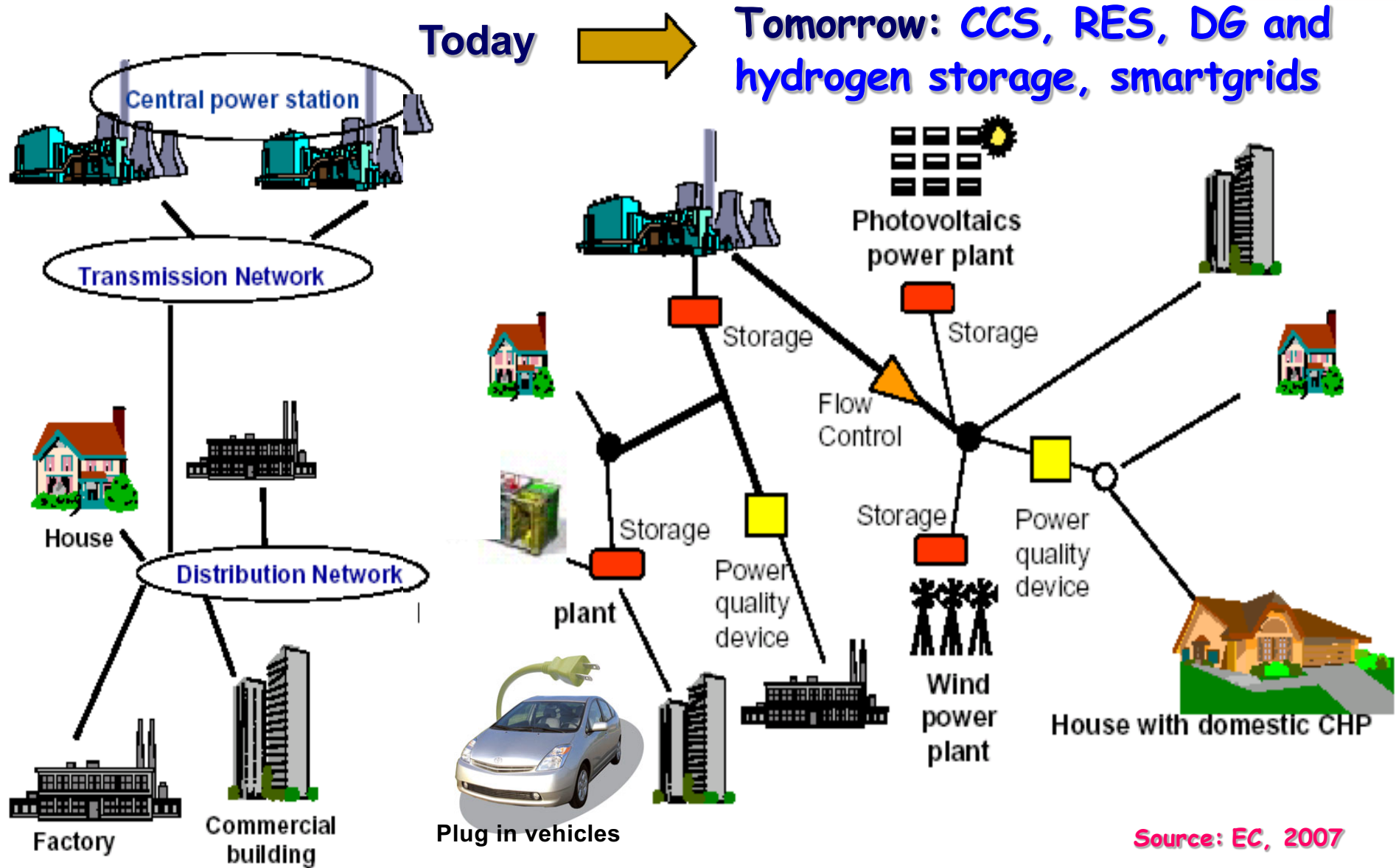

Source: EC, 2007

The Super Smart Grid after 2050* (may allow for 100% RES)

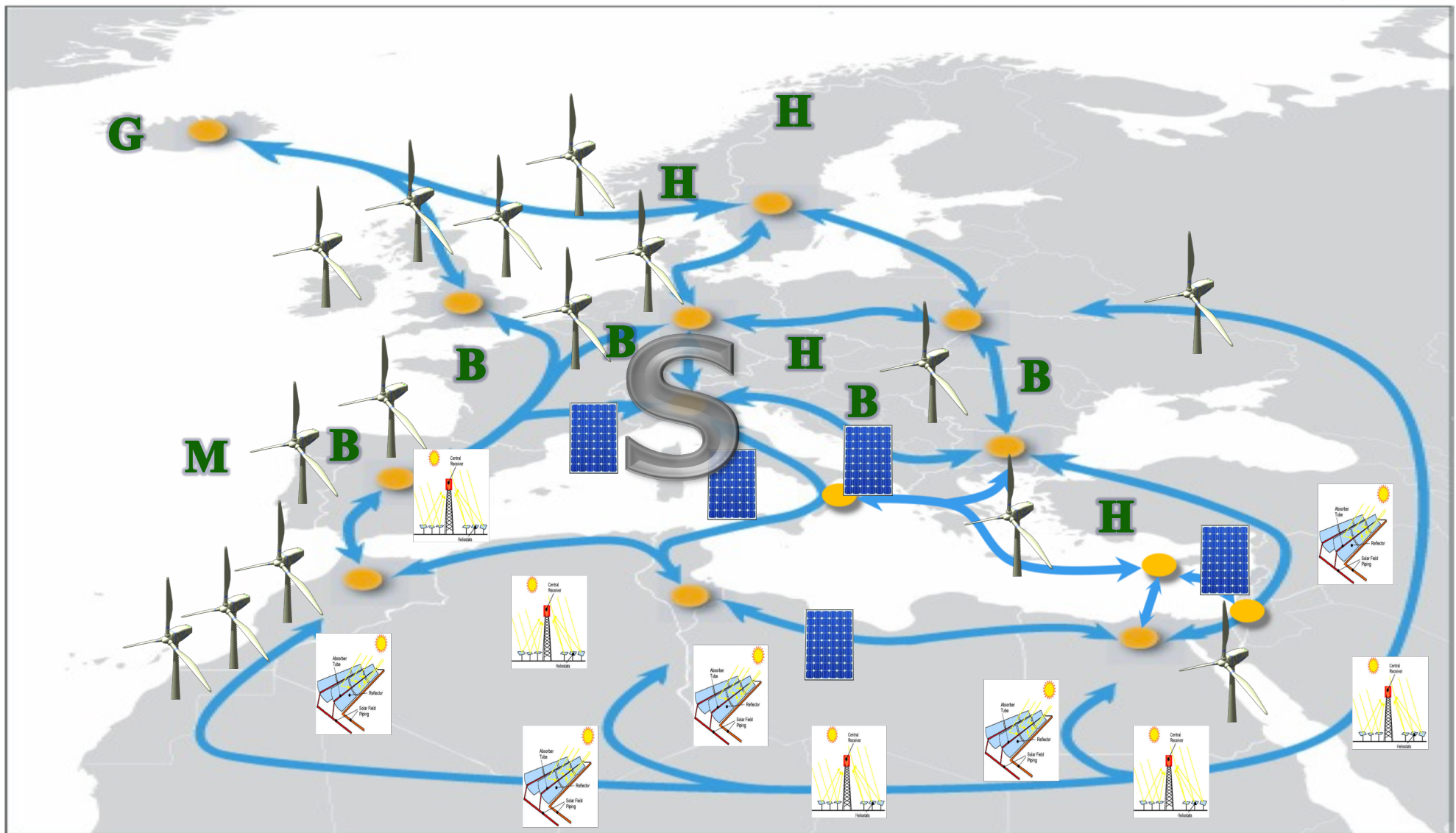

* Poullikas A., 2013, *Sustainable Energy Development for Cyprus*, ISBN: 978-9963-7355-3-2

Cyprus current electricity and NG system

Statistics

Existing power generation system

- **Steam turbine units (HFO)**
 - Dhekelia power station 6x60MWe
 - Vasilikos power station 3x130MWe
- **Combined cycles (Diesel)**
 - Vasilikos power station 2x220MWe
- **Gas turbine units (Diesel)**
 - Moni power station 4x37,5MWe
 - Vasilikos power station 1x38MWe
- **Renewables**
 - PVs 121MWe
 - Wind 157MWe
 - Biomass 13MWe

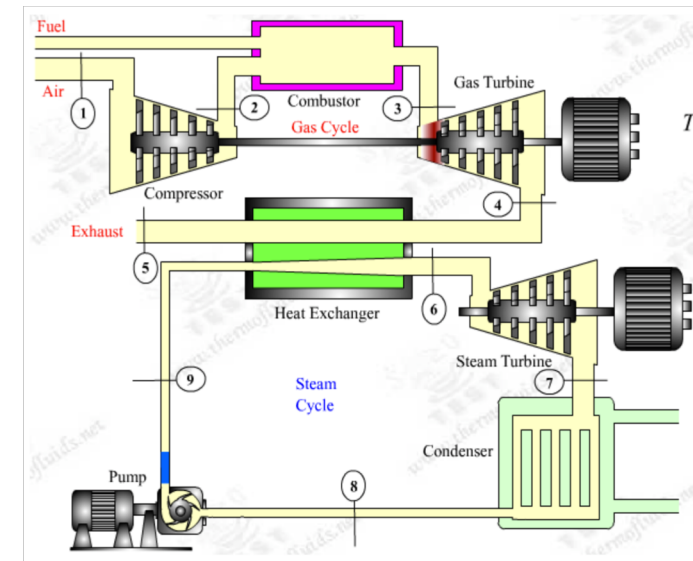

Distribution of RES-E

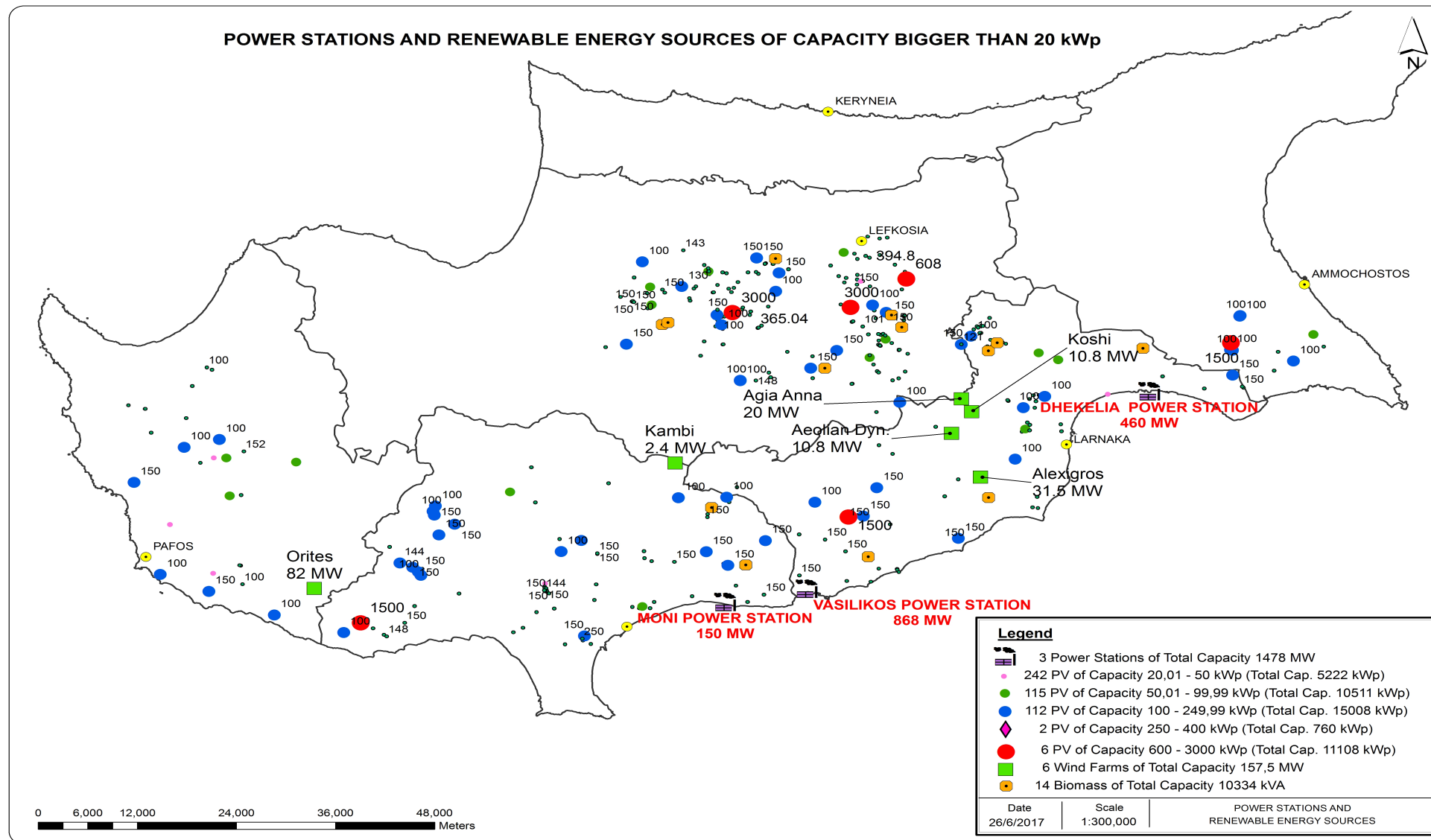

RES-E targets

- **Current RES-E penetration: ~9%**



- **PVs 121MWe**
- **Wind 157MWe**
- **Biomass 13MWe**

- **RES-E target for 2020: 16%**



- **PVs 288MWe**
- **CSP 50MWe or PVs 72MWe**
- **Wind 175MWe**
- **Biomass 15MWe**

- **RES-E target for 2030: not yet**

Existing natural gas system

- **Under development !**
- **For power generation as a start...**

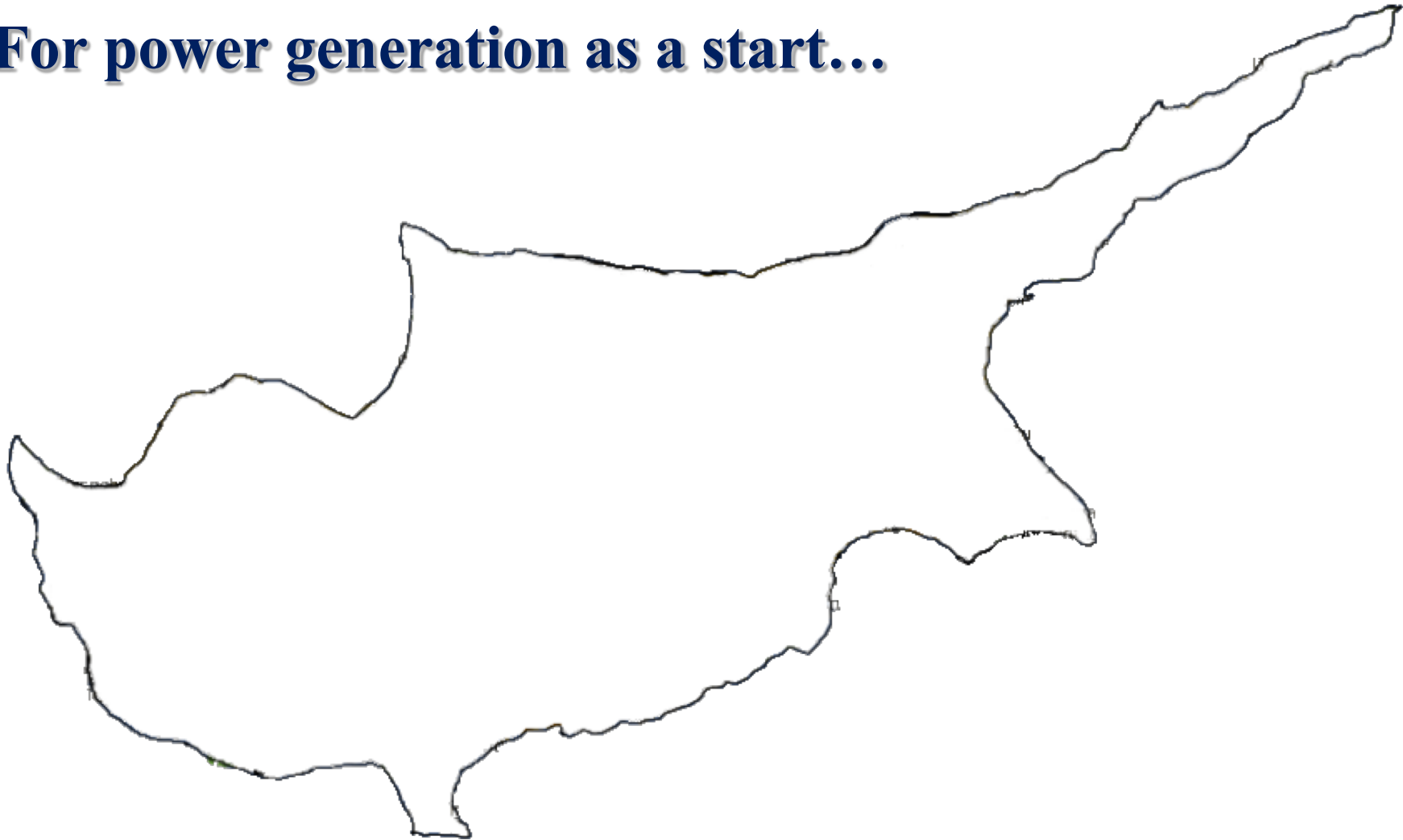

The role of natural gas

Towards sustainable energy systems

Pathways to low emissions

1. Gas is **clean**



gas produces
less than half as much
CO₂ per kWh than
electricity

2. Gas is **scalable**



Gas is sufficiently
abundant to continue to
meet a large share of
European and global
energy demand

3. Gas is **flexible**

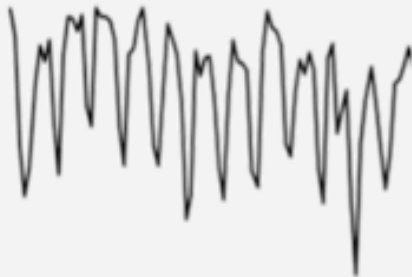

Gas can
quickly meet short
term fluctuations in
power demand where
other power sources
can not

3. Gas **technology** is improving

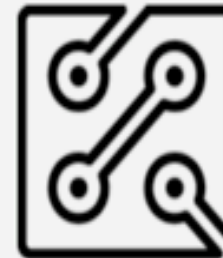

Gas technological
improvements are
driving energy efficiency
gains

Why gas is
perfectly suited
to play a pivotal
role in the
energy mix of
the future

Daily load curve (the 'camel curve')*

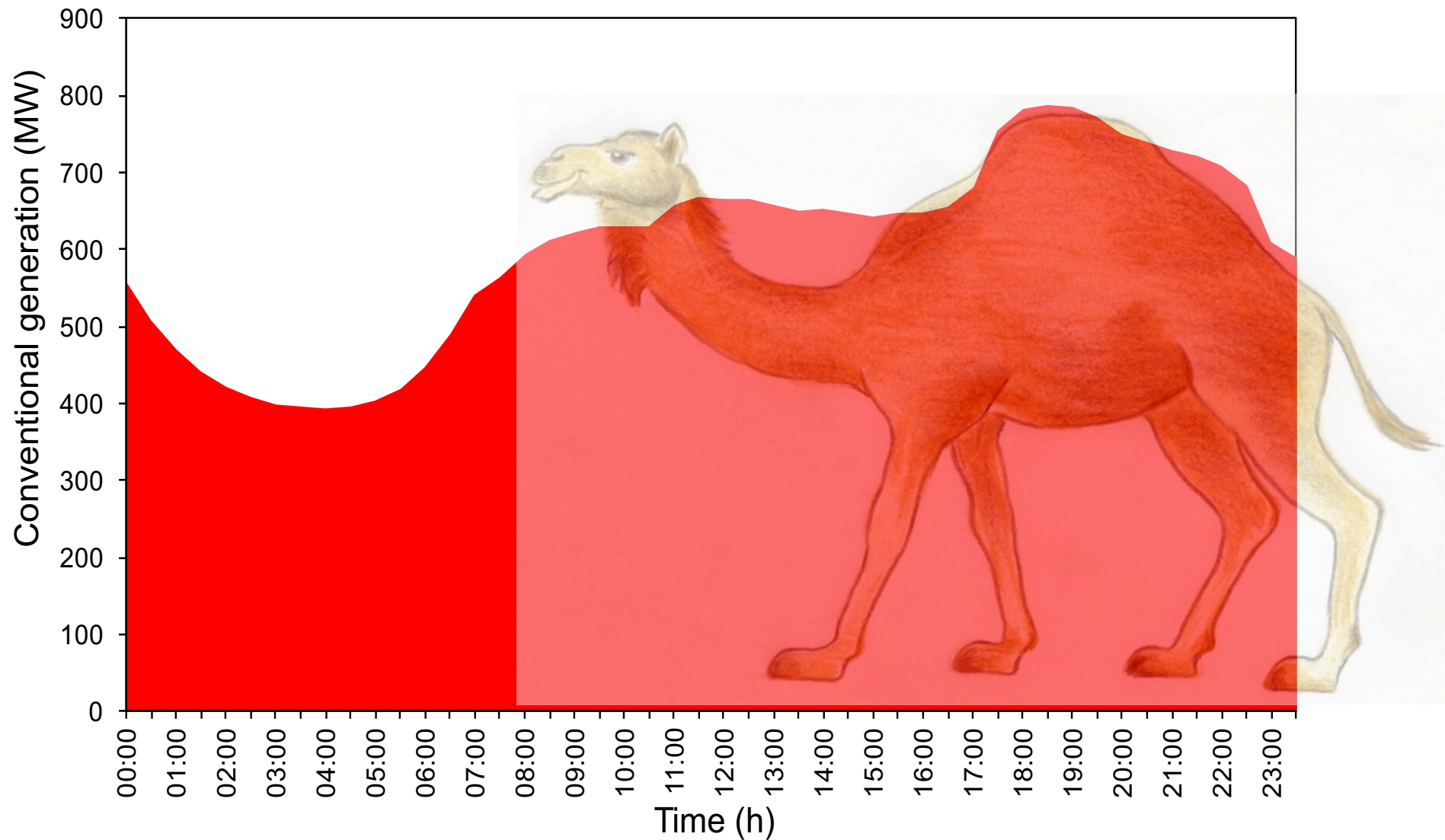

* **Poullikkas A., 2016, "From the 'camel curve' to the 'duck curve' on electric systems with increasing solar power", *Accountancy***

Effect of PV generation on load curve (the 'duck curve')*

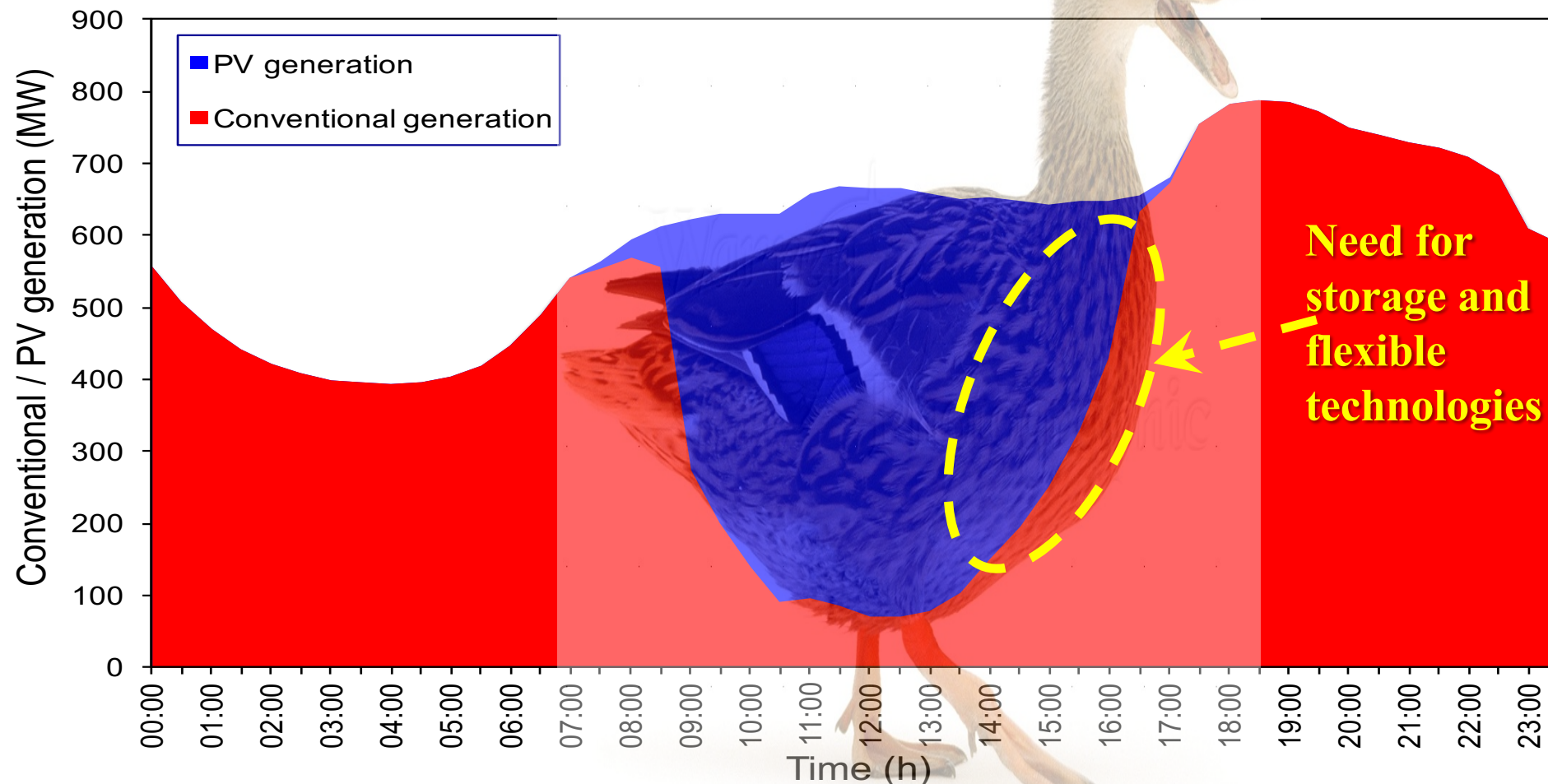

* Poullikkas A., 2016, "From the 'camel curve' to the 'duck curve' on electric systems with increasing solar power", *Accountancy*

Gas is a pillar of renewable energy (power production in UK*)

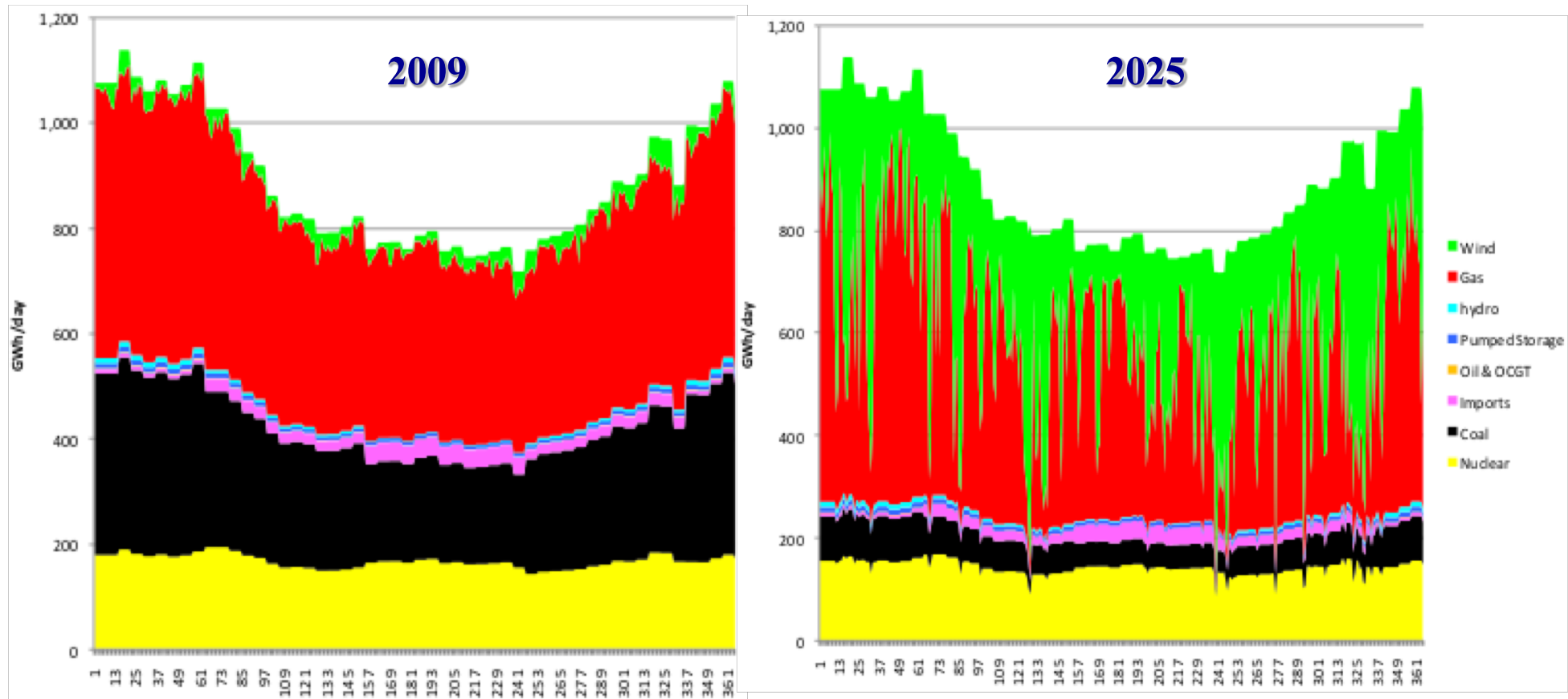

* H.V. Rogers, 2011, *The Impact of Import Dependence and Wind Generation on UK Gas Demand and Security of Supply to 2025*, The Oxford Institute For Energy Studies

Power-to-Gas (P2G)

- energy storage technology linking the electricity and gas infrastructure

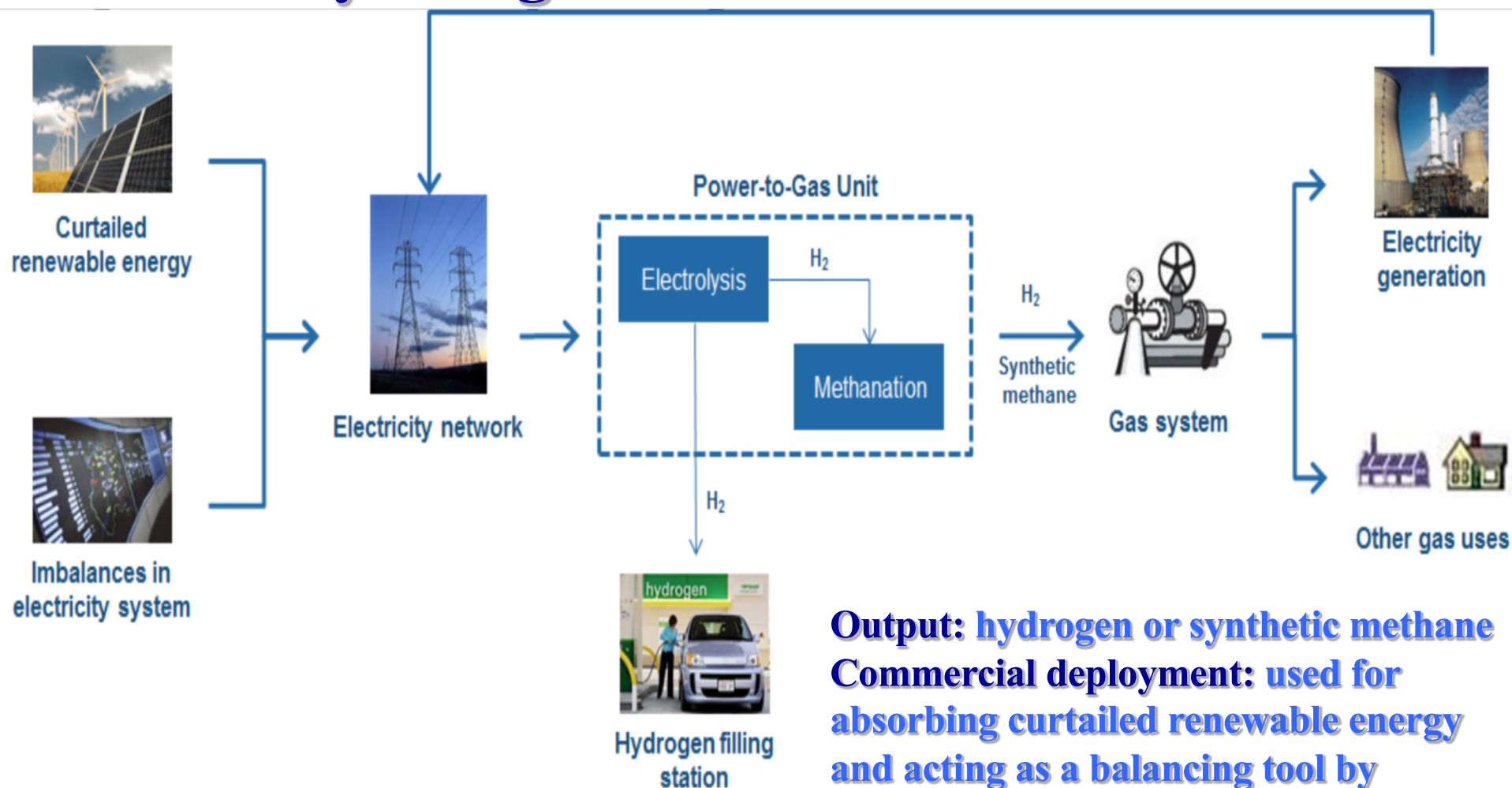

EU gas market target model

- **The new uses for gas have different roles across the gas supply chain**

